

SKM 400GB066D

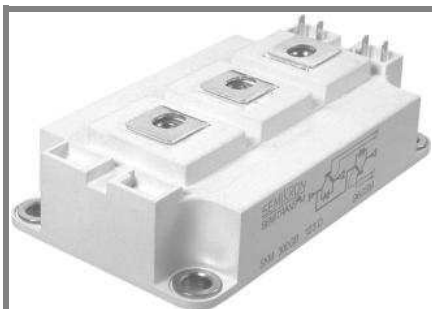

SEMITRANS® 3

Trench IGBT Modules

SKM 400GB066D

Features

- Trench = Trenchgate technology
- $V_{CE(sat)}$ with positive temperature coefficient
- High short circuit capability, self limiting to $6 \times I_C$

Typical Applications*

- AC inverter drives
- UPS
- Electronic welders

Remarks

- Case temperature limited to $T_C = 125^\circ\text{C}$ max, recommended $T_{op} = -40 \dots +150^\circ\text{C}$
- Product reliability results are valid for $T_j \leq 150^\circ\text{C}$
- Short circuit data: $t_p \leq 6 \text{ s}$; $V_{GE} \leq 15\text{V}$; $T_j = 150^\circ\text{C}$; $V_{CC} \leq 360\text{V}$, use of soft R_G necessary !
- Take care of over-voltage caused by stray inductances

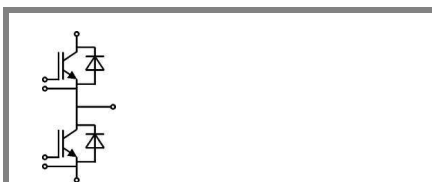

GB

Absolute Maximum Ratings		$T_{case} = 25^\circ\text{C}$, unless otherwise specified		
Symbol	Conditions	Values	Units	
IGBT				
V_{CES}	$T_j = 25^\circ\text{C}$	600	V	
I_C	$T_j = 175^\circ\text{C}$	$T_c = 25^\circ\text{C}$	500	A
		$T_c = 80^\circ\text{C}$	380	A
I_{CRM}	$I_{CRM} = 2 \times I_{Cnom}$	800	A	
V_{GES}		± 20	V	
t_{psc}	$V_{CC} = 360 \text{ V}$; $V_{GE} \leq 15 \text{ V}$; $T_j = 150^\circ\text{C}$ $V_{CES} < 600 \text{ V}$	6	μs	
Inverse Diode				
I_F	$T_j = 175^\circ\text{C}$	$T_c = 25^\circ\text{C}$	450	A
		$T_c = 80^\circ\text{C}$	320	A
I_{FRM}	$I_{FRM} = 2 \times I_{Fnom}$	800	A	
Module				
$I_{t(RMS)}$		500	A	
T_{vj}		-40 ... +175	$^\circ\text{C}$	
T_{stg}		-40 ... +125	$^\circ\text{C}$	
V_{isol}	AC, 1 min.	4000	V	

Characteristics		$T_{case} = 25^\circ\text{C}$, unless otherwise specified			
Symbol	Conditions	min.	typ.	max.	Units
IGBT					
$V_{GE(th)}$	$V_{GE} = V_{CE}$, $I_C = 6,4 \text{ mA}$	5	5,8	6,5	V
I_{CES}	$V_{GE} = 0 \text{ V}$, $V_{CE} = V_{CES}$		0,25	0,75	mA
V_{CE0}		$T_j = 25^\circ\text{C}$	0,9	1	V
		$T_j = 150^\circ\text{C}$	0,85	0,9	V
r_{CE}	$V_{GE} = 15 \text{ V}$	$T_j = 25^\circ\text{C}$	1,4	2,3	$\text{m}\Omega$
		$T_j = 150^\circ\text{C}$	2,1	3	$\text{m}\Omega$
$V_{CE(sat)}$	$I_{Cnom} = 400 \text{ A}$, $V_{GE} = 15 \text{ V}$	$T_j = 25^\circ\text{C}_{chiplev.}$	1,45	1,9	V
		$T_j = 150^\circ\text{C}_{chiplev.}$	1,7	2,1	V
C_{ies}	$V_{CE} = 25$, $V_{GE} = 0 \text{ V}$	$f = 1 \text{ MHz}$	24,7		nF
C_{oes}			1,54		nF
C_{res}			0,73		nF
Q_G	$V_{GE} = -8\text{V} \dots +15\text{V}$		3000		nC
R_{Gint}	$T_j = ^\circ\text{C}$		2		Ω
$t_{d(on)}$	$R_{Gon} = 1,5 \Omega$	$V_{CC} = 300\text{V}$ $I_C = 400\text{A}$	200		ns
t_r			60		ns
E_{on}	$R_{Goff} = 1,5 \Omega$	$T_j = 150^\circ\text{C}$ $V_{GE} = -8\text{V}/+15\text{V}$	8		mJ
$t_{d(off)}$			560		ns
t_f			53		ns
E_{off}			16		mJ
$R_{th(j-c)}$	per IGBT			0,12	K/W

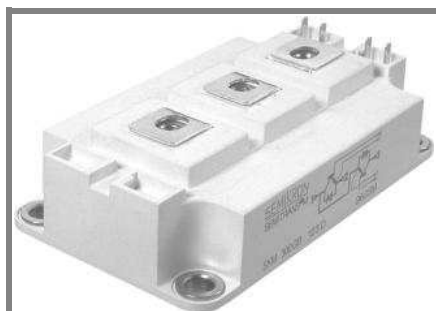

SEMITRANS® 3

Trench IGBT Modules

SKM 400GB066D

Features

- Trench = Trenchgate technology
- $V_{CE(sat)}$ with positive temperature coefficient
- High short circuit capability, self limiting to $6 \times I_C$

Typical Applications*

- AC inverter drives
- UPS
- Electronic welders

Remarks

- Case temperature limited to $T_C = 125^\circ\text{C}$ max, recommended $T_{op} = -40 \dots +150^\circ\text{C}$
- Product reliability results are valid for $T_j \leq 150^\circ\text{C}$
- Short circuit data: $t_p \leq 6 \text{ s}$; $V_{GE} \leq 15\text{V}$; $T_j = 150^\circ\text{C}$; $V_{CC} \leq 360\text{V}$, use of soft R_G necessary !
- Take care of over-voltage caused by stray inductances

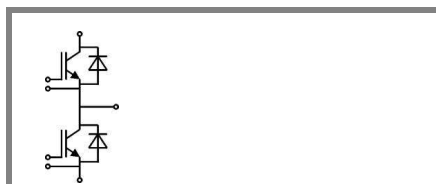

GB

Characteristics

Symbol	Conditions	min.	typ.	max.	Units
Inverse Diode					
$V_F = V_{EC}$	$I_{Fnom} = 400 \text{ A}$; $V_{GE} = 0 \text{ V}$ $T_j = 25^\circ\text{C}_{chiplev.}$		1,4	1,6	V
V_{F0}	$T_j = 25^\circ\text{C}$		0,95	1	V
r_F	$T_j = 25^\circ\text{C}$		1,1	1,5	mΩ
I_{RRM}	$I_F = 400 \text{ A}$ $T_j = 150^\circ\text{C}$		410		A
Q_{rr}	$di/dt = 7250 \text{ A/s}$		62		C
E_{rr}	$V_{GE} = -8 \text{ V}$; $V_{CC} = 300 \text{ V}$		14		mJ
$R_{th(j-c)D}$	per diode			0,2	K/W
Module					
L_{CE}			15	20	nH
R_{CC+EE}	res., terminal-chip $T_{case} = 25^\circ\text{C}$		0,35		mΩ
	$T_{case} = 125^\circ\text{C}$		0,5		mΩ
$R_{th(c-s)}$	per module			0,038	K/W
M_s	to heat sink M6	3		5	Nm
M_t	to terminals M6	2,5		5	Nm
w				325	g

This is an electrostatic discharge sensitive device (ESDS), international standard IEC 60747-1, chapter IX.

*IMPORTANT INFORMATION AND WARNINGS

The specifications of SEMIKRON products may not be considered as guarantee or assurance of product characteristics ("Beschaffensgarantie"). The specifications of SEMIKRON products describe only the usual characteristics of products to be expected in typical applications, which may still vary depending on the specific application. Therefore, products must be tested for the respective application in advance. Application adjustments may be necessary. The user of SEMIKRON products is responsible for the safety of their applications embedding SEMIKRON products and must take adequate safety measures to prevent the applications from causing a physical injury, fire or other problem if any of SEMIKRON products become faulty. The user is responsible to make sure that the application design is compliant with all applicable laws, regulations, norms and standards. Except as otherwise explicitly approved by SEMIKRON in a written document signed by authorized representatives of SEMIKRON, SEMIKRON products may not be used in any applications where a failure of the product or any consequences of the use thereof can reasonably be expected to result in personal injury. No representation or warranty is given and no liability is assumed with respect to the accuracy, completeness and/or use of any information herein, including without limitation, warranties of non-infringement of intellectual property rights of any third party. SEMIKRON does not assume any liability arising out of the applications or use of any product; neither does it convey any license under its patent rights, copyrights, trade secrets or other intellectual property rights, nor the rights of others. SEMIKRON makes no representation or warranty of non-infringement or alleged non-infringement of intellectual property rights of any third party which may arise from applications. Due to technical requirements our products may contain dangerous substances. For information on the types in question please contact the nearest SEMIKRON sales office. This document supersedes and replaces all information previously supplied and may be superseded by updates. SEMIKRON reserves the right to make changes.

SKM 400GB066D

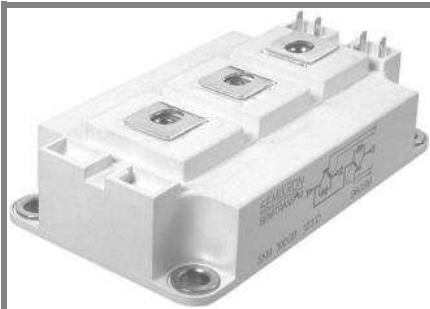

SEMITRANS® 3

Trench IGBT Modules

SKM 400GB066D

Features

- Trench = Trenchgate technology
- $V_{CE(sat)}$ with positive temperature coefficient
- High short circuit capability, self limiting to $6 \times I_C$

Typical Applications*

- AC inverter drives
- UPS
- Electronic welders

Remarks

- Case temperature limited to $T_C = 125^\circ\text{C}$ max, recommended $T_{op} = -40 \dots +150^\circ\text{C}$
- Product reliability results are valid for $T_j \leq 150^\circ\text{C}$
- Short circuit data: $t_p \leq 6$ s; $V_{GE} \leq 15\text{V}$; $T_j = 150^\circ\text{C}$; $V_{cc} \leq 360\text{V}$, use of soft R_G necessary !
- Take care of over-voltage caused by stray inductances



GB

Z_{th}		Conditions	Values	Units
Symbol				
$Z_{th(j-c)I}$				
$R_{\theta j-c}$	$i = 1$		80	mk/W
$R_{\theta j-c}$	$i = 2$		22,5	mk/W
$R_{\theta j-c}$	$i = 3$		6,4	mk/W
$R_{\theta j-c}$	$i = 4$		1,1	mk/W
$\tau_{th(j-c)I}$	$i = 1$		0,0447	s
$\tau_{th(j-c)I}$	$i = 2$		0,0223	s
$\tau_{th(j-c)I}$	$i = 3$		0,0015	s
$\tau_{th(j-c)I}$	$i = 4$		0,0002	s
Symbol				
$Z_{th(j-c)D}$				
$R_{\theta j-c}$	$i = 1$		130	mk/W
$R_{\theta j-c}$	$i = 2$		55	mk/W
$R_{\theta j-c}$	$i = 3$		12,5	mk/W
$R_{\theta j-c}$	$i = 4$		2,5	mk/W
$\tau_{th(j-c)D}$	$i = 1$		0,054	s
$\tau_{th(j-c)D}$	$i = 2$		0,01	s
$\tau_{th(j-c)D}$	$i = 3$		0,0015	s
$\tau_{th(j-c)D}$	$i = 4$		0,1	s

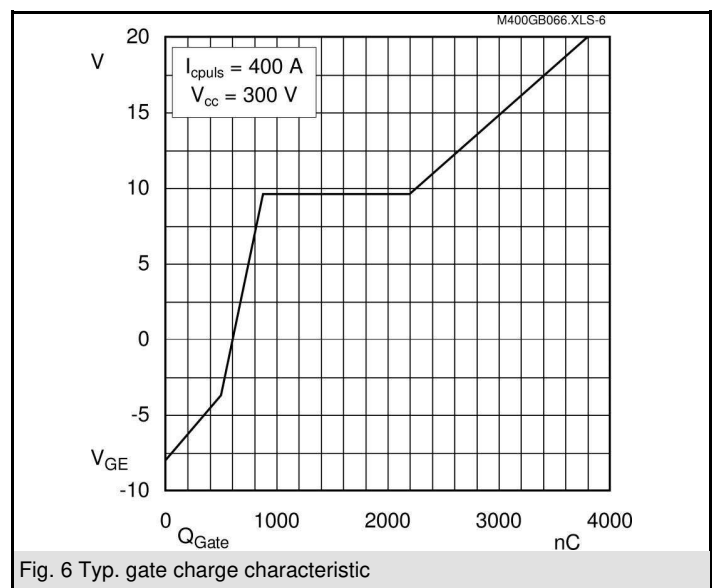
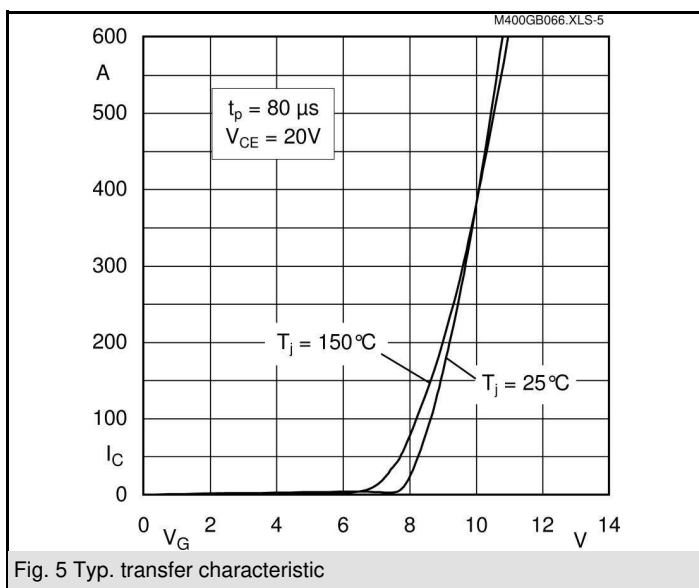
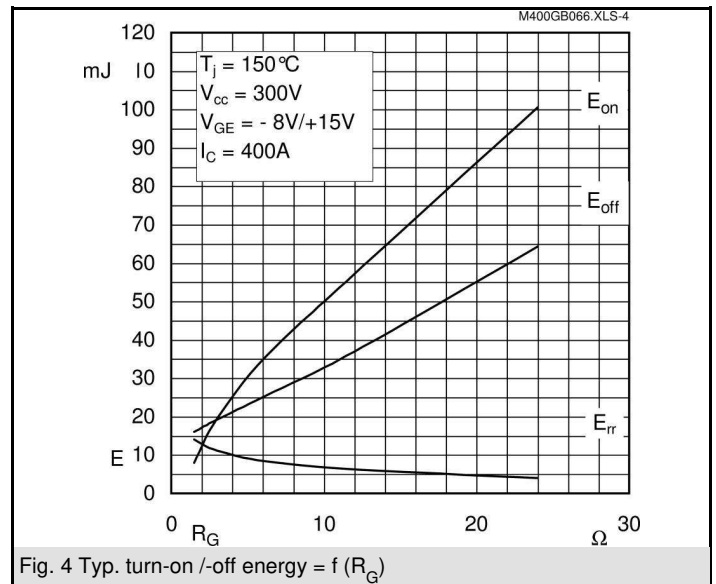
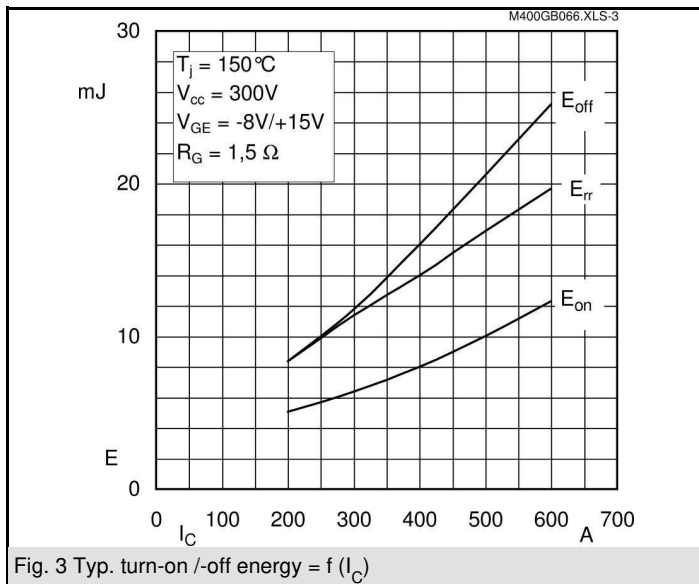
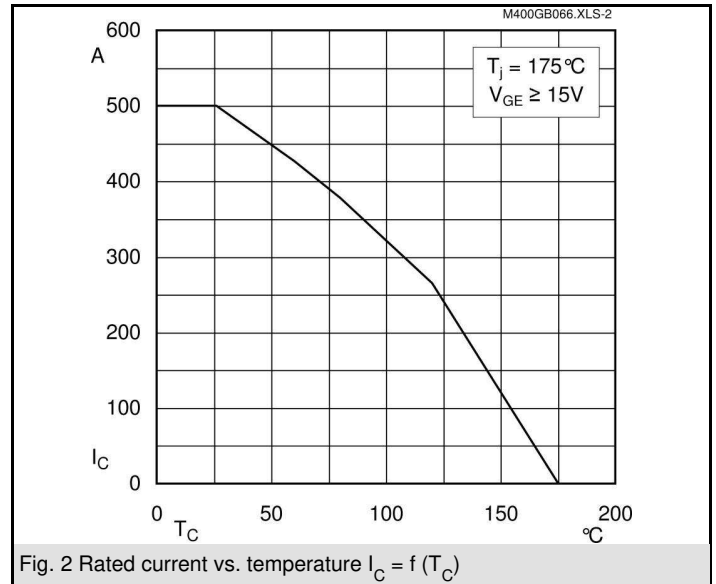
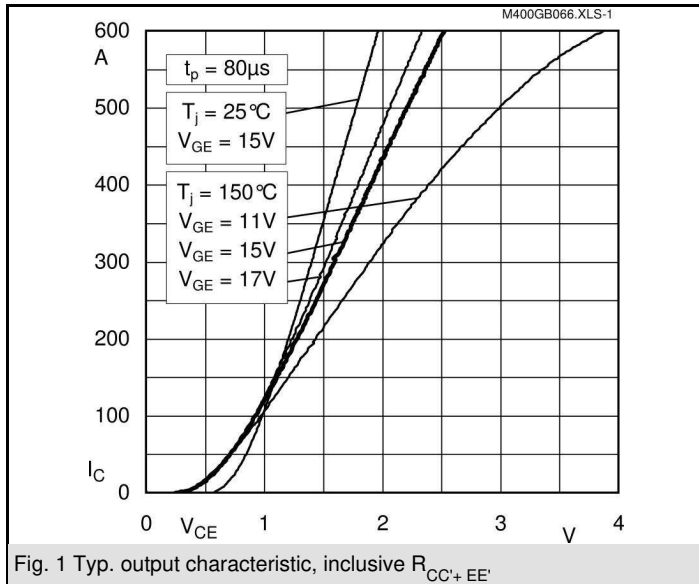

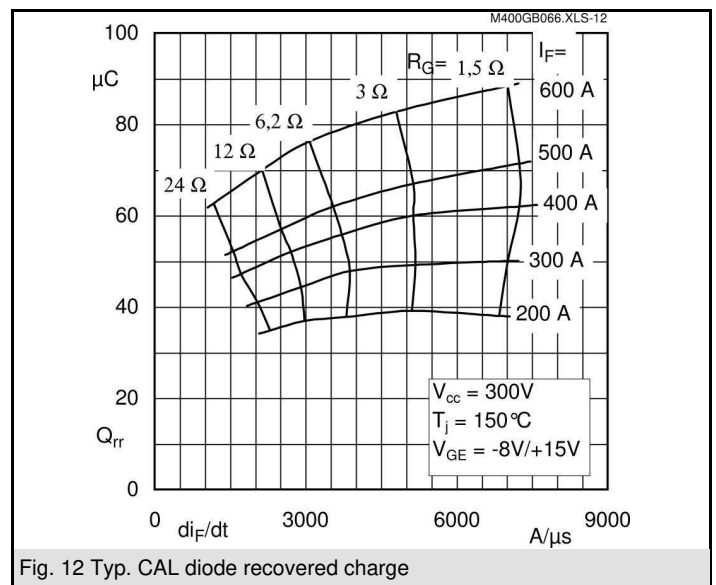
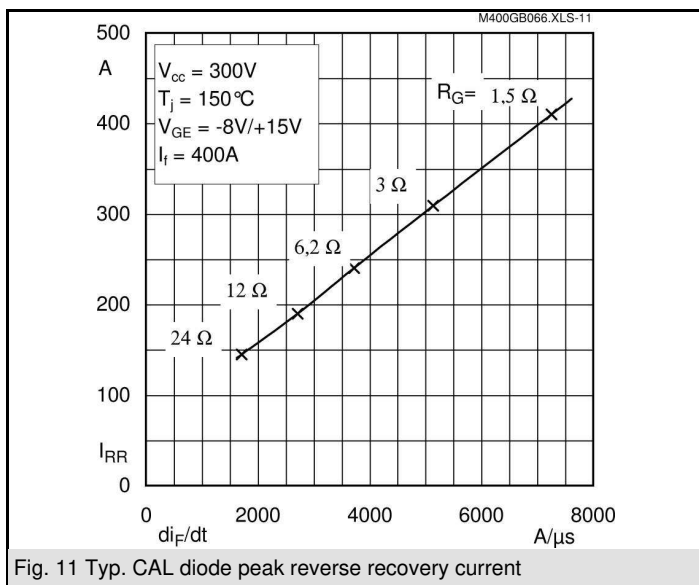
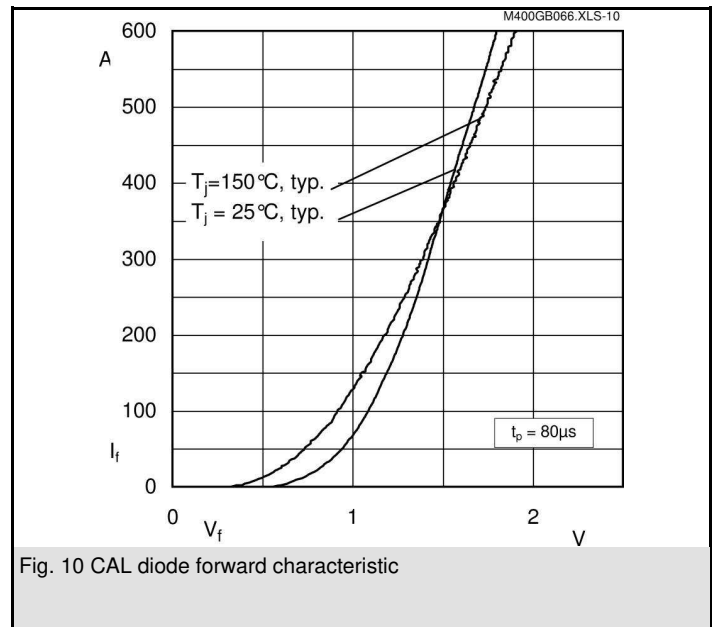
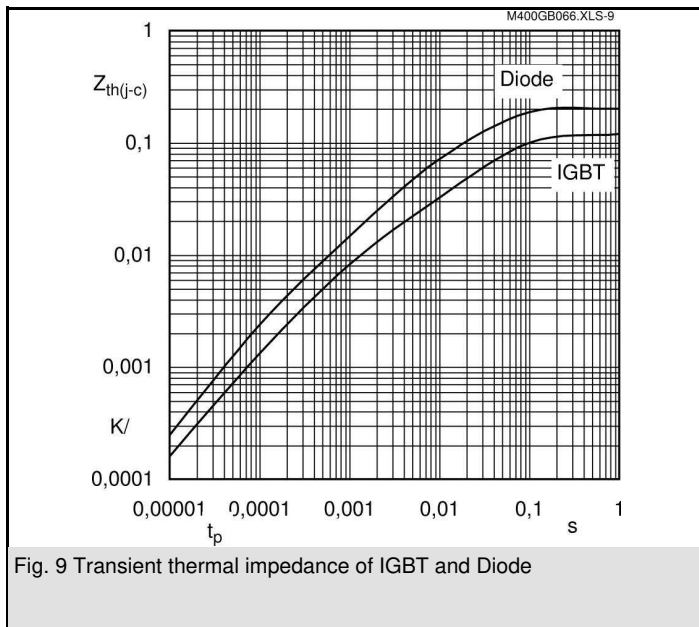
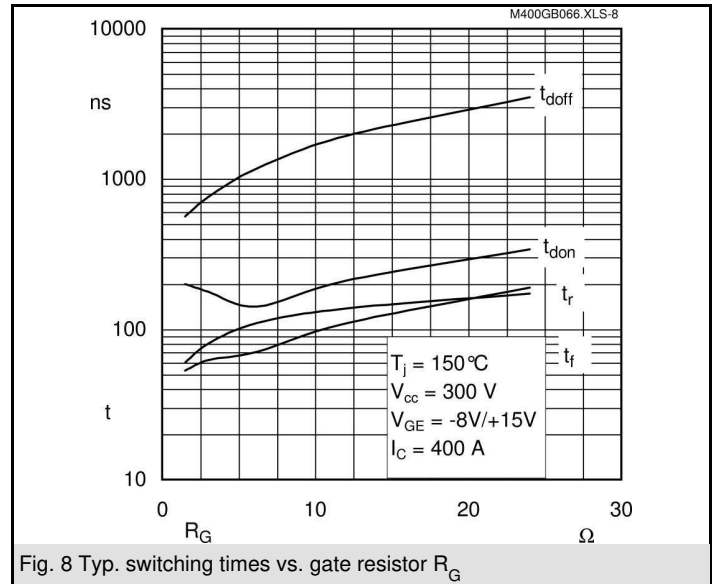
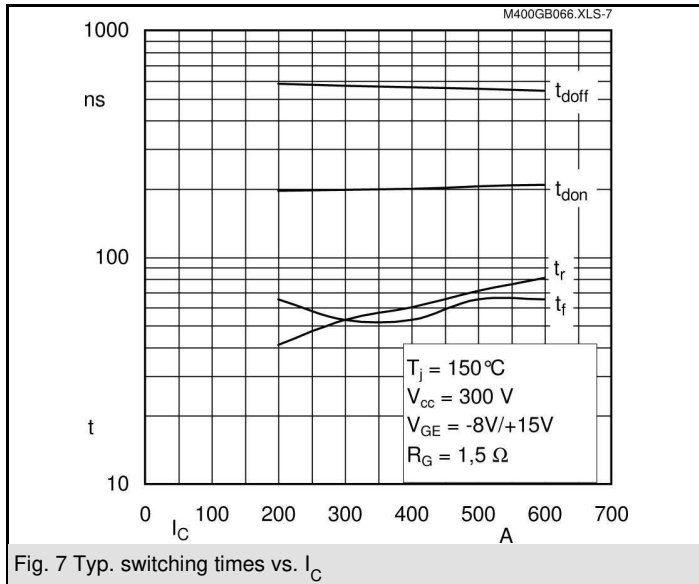

SKM 400GB066D

UL recognized, file no. E 63 532

CASED56

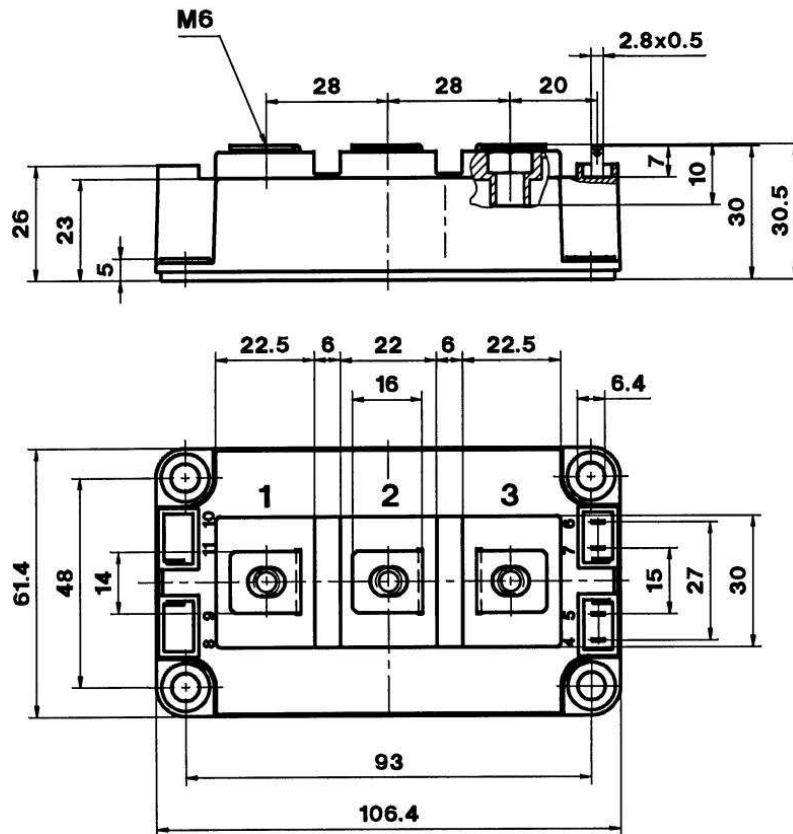

Case D 56

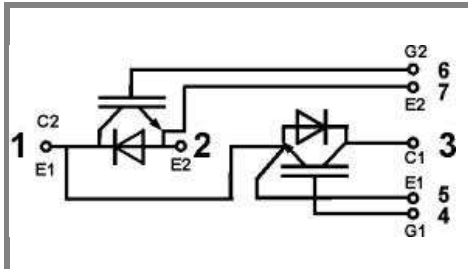

GB

Case D56