

# SEMiX453GAR12E4s



SEMiX® 3s

## Trench IGBT Modules

### SEMiX453GAR12E4s

#### Features

- Homogeneous Si
- Trench = Trenchgate technology
- $V_{CE(sat)}$  with positive temperature coefficient
- High short circuit capability
- UL recognized, file no. E63532

#### Typical Applications\*

- AC inverter drives
- UPS
- Electronic Welding

#### Remarks

- Case temperature limited to  $T_C=125^\circ\text{C}$  max.
- Product reliability results are valid for  $T_j=150^\circ\text{C}$
- Dynamic values apply to the following combination of resistors:  
 $R_{Gon,main} = 1,0 \Omega$   
 $R_{Goff,main} = 1,0 \Omega$   
 $R_{G,X} = 2,2 \Omega$   
 $R_{E,X} = 0,5 \Omega$

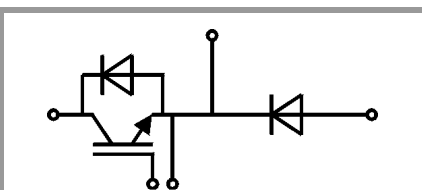

GAR

#### Absolute Maximum Ratings

Symbol	Conditions	Values	Unit	
<b>IGBT</b>				
$V_{CES}$	$T_j = 25^\circ\text{C}$	1200	V	
$I_C$	$T_j = 175^\circ\text{C}$	$T_c = 25^\circ\text{C}$	683	A
		$T_c = 80^\circ\text{C}$	526	A
$I_{Cnom}$		450	A	
$I_{CRM}$	$I_{CRM} = 3 \times I_{Cnom}$	1350	A	
$V_{GES}$		-20 ... 20	V	
$t_{psc}$	$V_{CC} = 800\text{ V}$ $V_{GE} \leq 20\text{ V}$ $V_{CES} \leq 1200\text{ V}$	$T_j = 150^\circ\text{C}$	10	$\mu\text{s}$
	$T_j$			
<b>Inverse diode</b>				
$I_F$	$T_j = 175^\circ\text{C}$	$T_c = 25^\circ\text{C}$	544	A
		$T_c = 80^\circ\text{C}$	407	A
$I_{Fnom}$		450	A	
$I_{FRM}$	$I_{FRM} = 3 \times I_{Fnom}$	1350	A	
$I_{FSM}$	$t_p = 10\text{ ms, sin } 180^\circ, T_j = 25^\circ\text{C}$	2430	A	
$T_j$		-40 ... 175	$^\circ\text{C}$	
<b>Freewheeling diode</b>				
$I_F$	$T_j = 175^\circ\text{C}$	$T_c = 25^\circ\text{C}$	544	A
		$T_c = 80^\circ\text{C}$	407	A
$I_{Fnom}$		450	A	
$I_{FRM}$	$I_{FRM} = 3 \times I_{Fnom}$	1350	A	
$I_{FSM}$	$t_p = 10\text{ ms, sin } 180^\circ, T_j = 25^\circ\text{C}$	2430	A	
$T_j$		-40 ... 175	$^\circ\text{C}$	
<b>Module</b>				
$I_{t(RMS)}$	$T_{terminal} = 80^\circ\text{C}$	600	A	
$T_{stg}$		-40 ... 125	$^\circ\text{C}$	
$V_{isol}$	AC sinus 50Hz, $t = 1\text{ min}$	4000	V	

#### Characteristics

Symbol	Conditions	min.	typ.	max.	Unit
<b>IGBT</b>					
$V_{CE(sat)}$	$I_C = 450\text{ A}$ $V_{GE} = 15\text{ V}$ chipelevel	$T_j = 25^\circ\text{C}$	1.8	2.05	V
		$T_j = 150^\circ\text{C}$	2.2	2.4	V
$V_{CE0}$	chipelevel	$T_j = 25^\circ\text{C}$	0.8	0.9	V
		$T_j = 150^\circ\text{C}$	0.7	0.8	V
$r_{CE}$	$V_{GE} = 15\text{ V}$ chipelevel	$T_j = 25^\circ\text{C}$	2.2	2.6	$\text{m}\Omega$
		$T_j = 150^\circ\text{C}$	3.3	3.6	$\text{m}\Omega$
$V_{GE(th)}$	$V_{GE}=V_{CE}, I_C = 18\text{ mA}$	5	5.8	6.5	V
$I_{CES}$	$V_{GE} = 0\text{ V}$ $V_{CE} = 1200\text{ V}$	$T_j = 25^\circ\text{C}$		5	$\text{mA}$
		$T_j = 150^\circ\text{C}$			$\text{mA}$
$C_{ies}$	$V_{CE} = 25\text{ V}$		27.9		$\text{nF}$
$C_{oes}$	$V_{GE} = 0\text{ V}$		1.74		$\text{nF}$
$C_{res}$			1.53		$\text{nF}$
$Q_G$	$V_{GE} = -8\text{ V...} + 15\text{ V}$		2550		$\text{nC}$
$R_{Gint}$	$T_j = 25^\circ\text{C}$		1.67		$\Omega$

# SEMiX453GAR12E4s



SEMiX® 3s

## Trench IGBT Modules

### SEMiX453GAR12E4s

#### Features

- Homogeneous Si
- Trench = Trenchgate technology
- $V_{CE(sat)}$  with positive temperature coefficient
- High short circuit capability
- UL recognized, file no. E63532

#### Typical Applications\*

- AC inverter drives
- UPS
- Electronic Welding

#### Remarks

- Case temperature limited to  $T_C=125^\circ\text{C}$  max.
- Product reliability results are valid for  $T_J=150^\circ\text{C}$
- Dynamic values apply to the following combination of resistors:  
 $R_{Gon,main} = 1,0 \Omega$   
 $R_{Goff,main} = 1,0 \Omega$   
 $R_{G,X} = 2,2 \Omega$   
 $R_{E,X} = 0,5 \Omega$

Characteristics						
Symbol	Conditions		min.	typ.	max.	Unit
$t_{d(on)}$	$V_{CC} = 600 \text{ V}$	$T_J = 150^\circ\text{C}$		336		ns
$t_r$	$I_C = 450 \text{ A}$	$T_J = 150^\circ\text{C}$		80		ns
$E_{on}$	$V_{GE} = \pm 15 \text{ V}$	$T_J = 150^\circ\text{C}$		45		mJ
$t_{d(off)}$	$R_{G on} = 1.9 \Omega$	$T_J = 150^\circ\text{C}$		615		ns
$t_f$	$R_{G off} = 1.9 \Omega$	$T_J = 150^\circ\text{C}$		130		ns
$E_{off}$	$di/dt_{on} = 4000 \text{ A}/\mu\text{s}$	$T_J = 150^\circ\text{C}$		66.5		mJ
	$di/dt_{off} = 5000 \text{ A}/\mu\text{s}$	$T_J = 150^\circ\text{C}$				
$R_{th(j-c)}$	per IGBT				0.065	K/W
Inverse diode						
$V_F = V_{EC}$	$I_F = 450 \text{ A}$	$T_J = 25^\circ\text{C}$		2.1	2.46	V
	$V_{GE} = 0 \text{ V}$	$T_J = 150^\circ\text{C}$		2.1	2.4	V
	chiplevel					
$V_{F0}$		$T_J = 25^\circ\text{C}$	1.1	1.3	1.5	V
	chiplevel	$T_J = 150^\circ\text{C}$	0.7	0.9	1.1	V
$r_F$		$T_J = 25^\circ\text{C}$	1.4	1.9	2.1	m $\Omega$
	chiplevel	$T_J = 150^\circ\text{C}$	2.2	2.6	2.8	m $\Omega$
$I_{RRM}$	$I_F = 450 \text{ A}$	$T_J = 150^\circ\text{C}$		350		A
$Q_{rr}$	$di/dt_{off} = 5000 \text{ A}/\mu\text{s}$	$T_J = 150^\circ\text{C}$		70		$\mu\text{C}$
$E_{rr}$	$V_{GE} = -15 \text{ V}$	$T_J = 150^\circ\text{C}$		28		mJ
	$V_{CC} = 600 \text{ V}$	$T_J = 150^\circ\text{C}$				
$R_{th(j-c)}$	per diode				0.11	K/W
Freewheeling diode						
$V_F = V_{EC}$	$I_F = 450 \text{ A}$	$T_J = 25^\circ\text{C}$		2.1	2.46	V
	$V_{GE} = 0 \text{ V}$	$T_J = 150^\circ\text{C}$		2.1	2.4	V
	chiplevel					
$V_{F0}$		$T_J = 25^\circ\text{C}$	1.1	1.3	1.5	V
	chiplevel	$T_J = 150^\circ\text{C}$	0.7	0.9	1.1	V
$r_F$		$T_J = 25^\circ\text{C}$	1.4	1.9	2.1	m $\Omega$
	chiplevel	$T_J = 150^\circ\text{C}$	2.2	2.6	2.8	m $\Omega$
$I_{RRM}$	$I_F = 450 \text{ A}$	$T_J = 150^\circ\text{C}$		350		A
$Q_{rr}$	$di/dt_{off} = 5000 \text{ A}/\mu\text{s}$	$T_J = 150^\circ\text{C}$		70		$\mu\text{C}$
$E_{rr}$	$V_{GE} = -15 \text{ V}$	$T_J = 150^\circ\text{C}$		28		mJ
	$V_{CC} = 600 \text{ V}$	$T_J = 150^\circ\text{C}$				
$R_{th(j-c)}$	per diode				0.11	K/W
Module						
$L_{CE}$				20		nH
$R_{CC+EE}$	res., terminal-chip	$T_C = 25^\circ\text{C}$		0.7		m $\Omega$
		$T_C = 125^\circ\text{C}$		1		m $\Omega$
$R_{th(c-s)}$	per module			0.04		K/W
$M_s$	to heat sink (M5)		3		5	Nm
$M_t$		to terminals (M6)	2.5		5	Nm
						Nm
w					300	g
Temperature Sensor						
$R_{100}$	$T_C=100^\circ\text{C}$ ( $R_{25}=5 \text{ k}\Omega$ )			$493 \pm 5\%$		$\Omega$
$B_{100/125}$	$R(T)=R_{100}\exp[B_{100/125}(1/T-1/T_{100})]$ ; $T[\text{K}]$ ;			$3550 \pm 2\%$		K

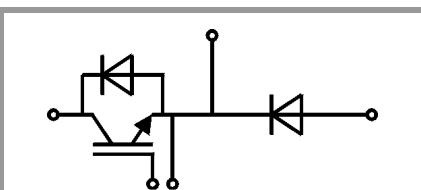

GAR

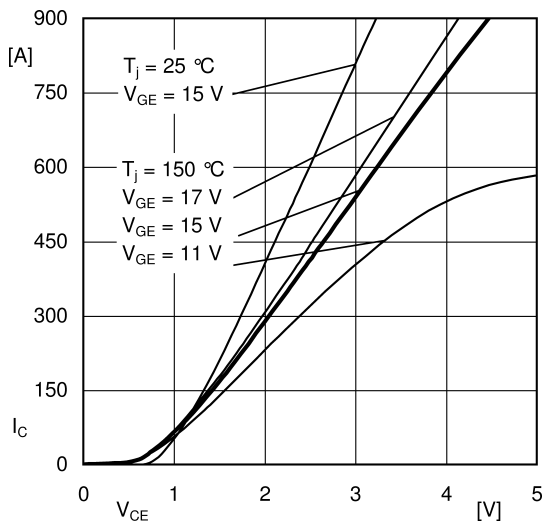

Fig. 1: Typ. output characteristic, inclusive  $R_{CC'+EE'}$

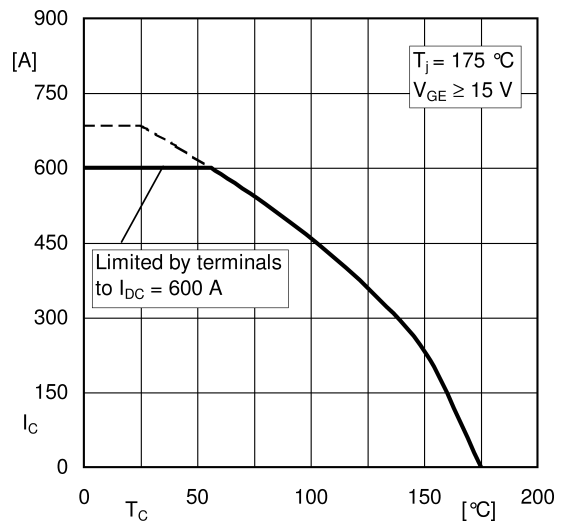

Fig. 2: Rated current vs. temperature  $I_C = f(T_C)$

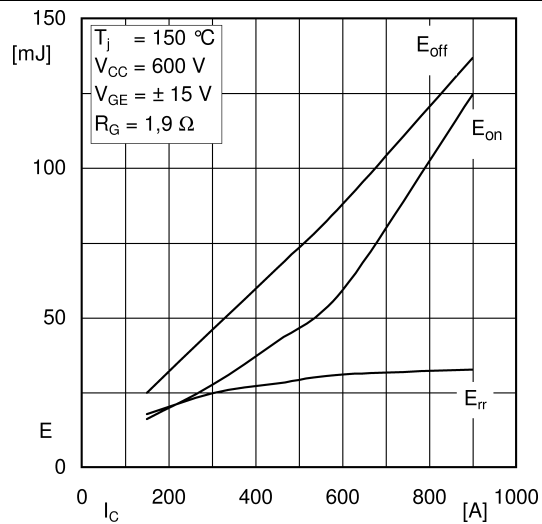

Fig. 3: Typ. turn-on /-off energy =  $f(I_C)$

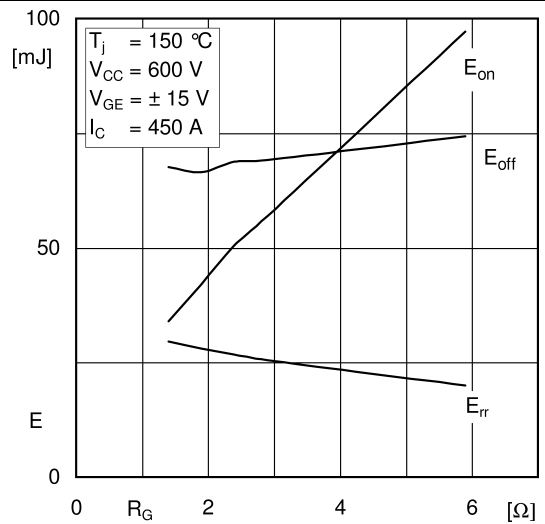

Fig. 4: Typ. turn-on /-off energy =  $f(R_G)$

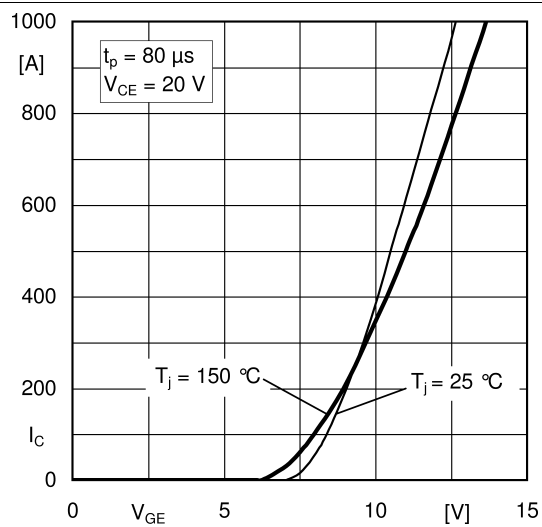

Fig. 5: Typ. transfer characteristic

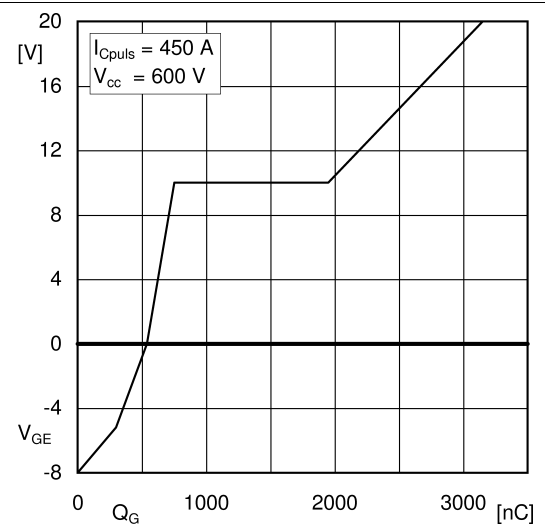
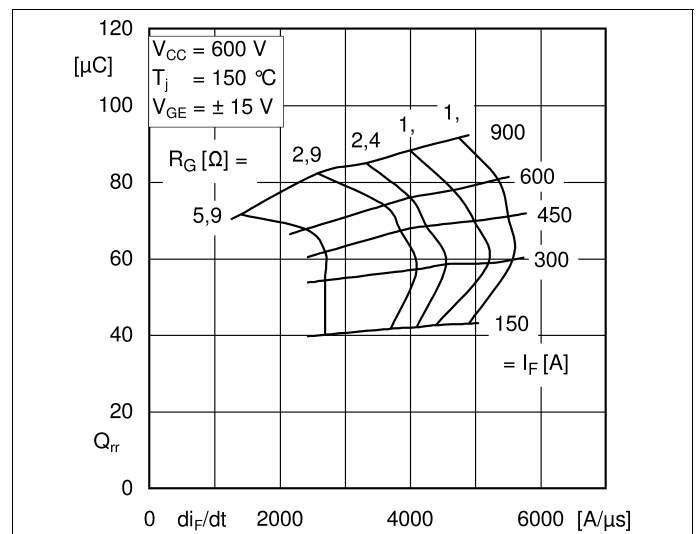
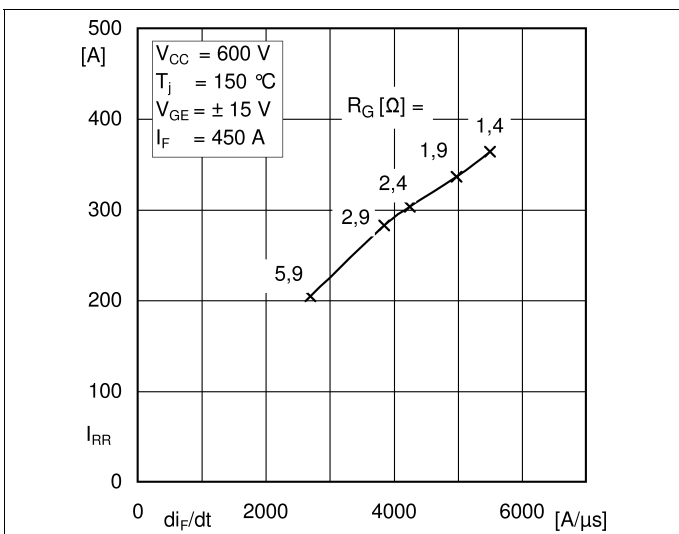
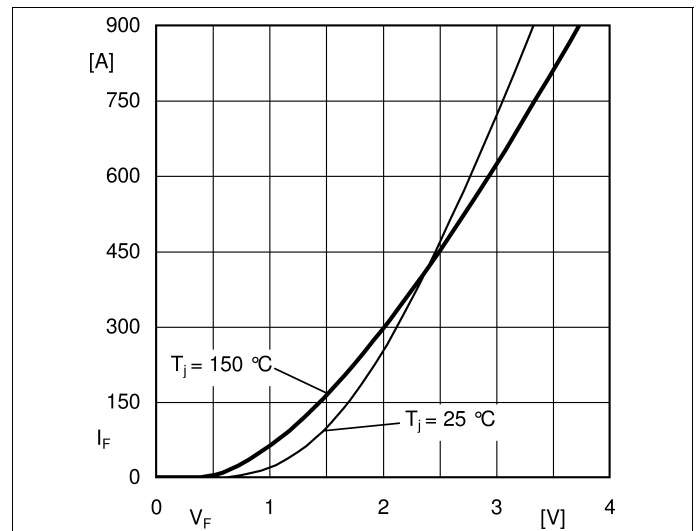
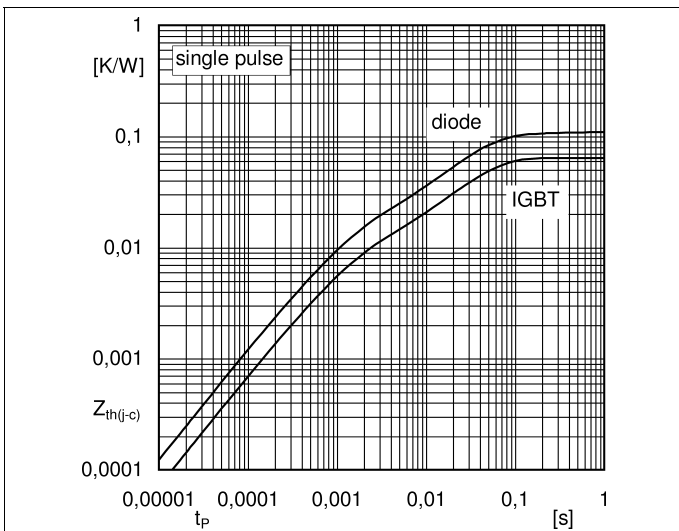
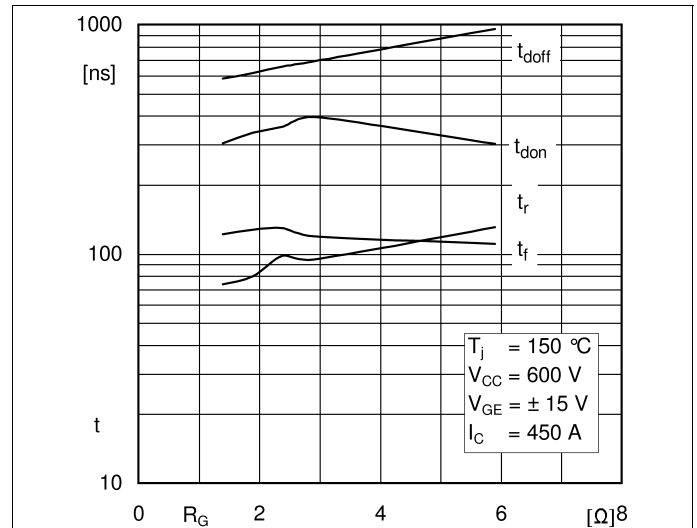
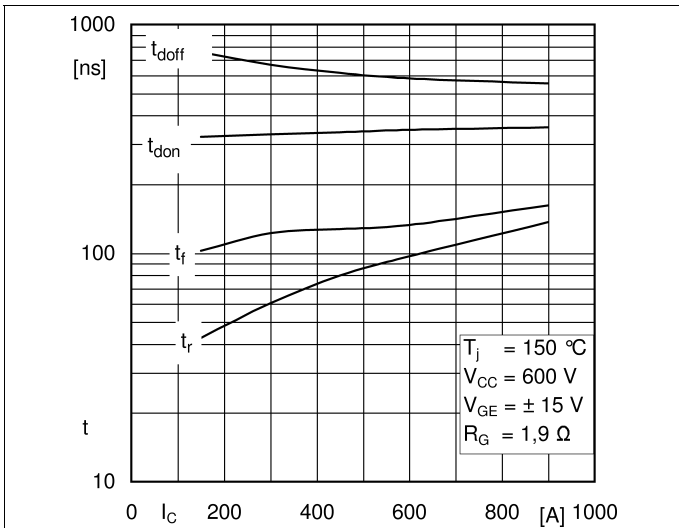

Fig. 6: Typ. gate charge characteristic



# SEMiX453GAR12E4s

Case: SEMiX 3s

guide pin left  
F-F (1 : 1)

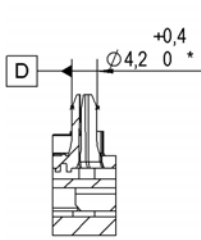

screw duct  
(1x centre):  
H-H (1 : 1)

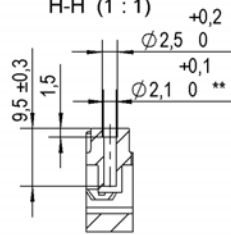

	0,3	connector 1-2 / 3-4
	0,2	each connector

general tolerance:  
ISO 2768-m  
ISO 8015

screw duct (6x)  
spring duct (16x):  
G-G (1 : 1)

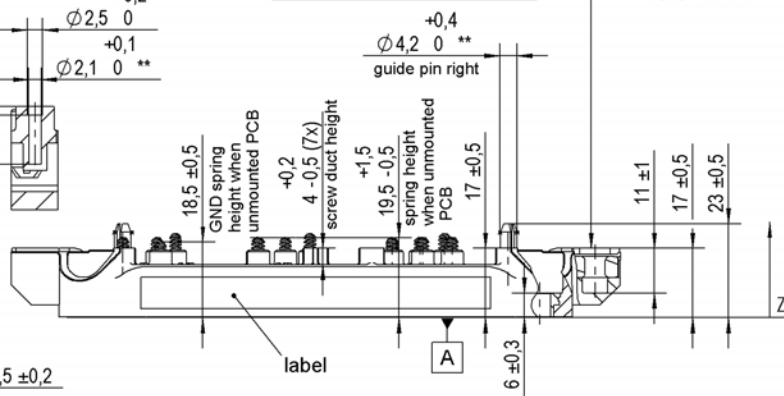
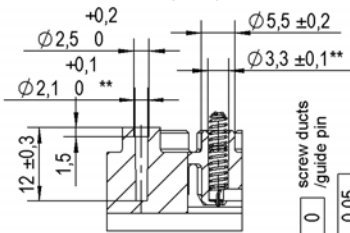

All measures in Z-direction  
valid when mounted to heat sink

marking of  
terminals

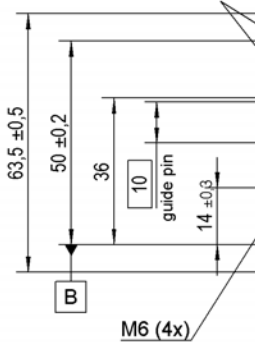

screw duct  
top view(7x):  
J (2 : 1)

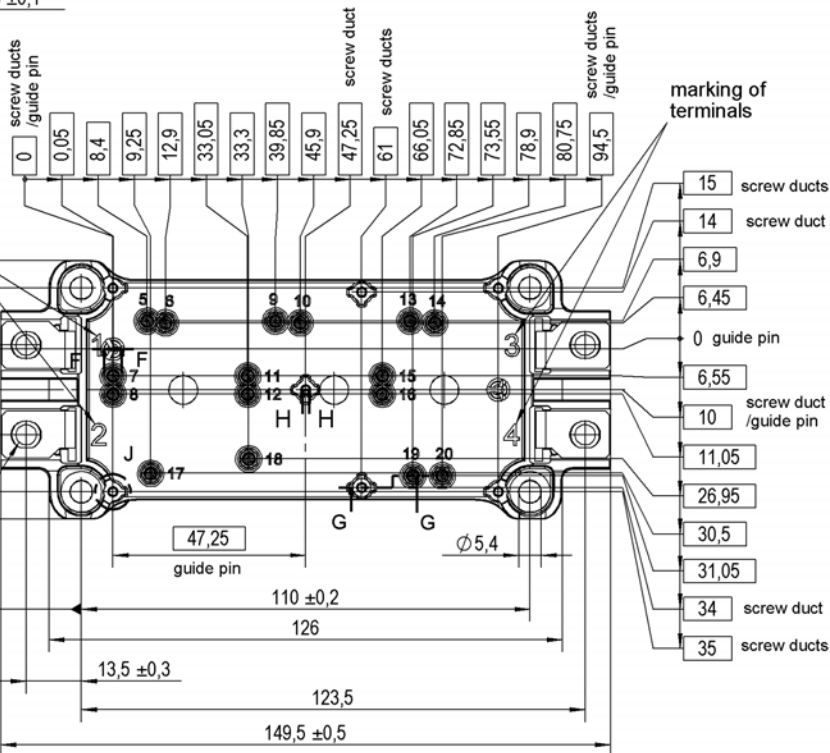
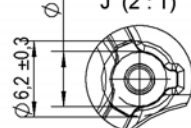

\*guide pin left with

	0,25	A	B	C
--	------	---	---	---

\*\*screw ducts / spring ducts / guide pin right with

	0,5	A	B	D
--	-----	---	---	---

Rules for the contact PCB:

- holes guidepins =  $\varnothing 4 \pm 0,1$  / position tolerance  $\pm 0,1$
- holes for screws =  $\varnothing 3,3 \pm 0,1$  / position tolerance  $\pm 0,1$
- spring contact pad =  $\varnothing 3,6 \pm 0,1$  / position tolerance  $\pm 0,1$

SEMIX 3s

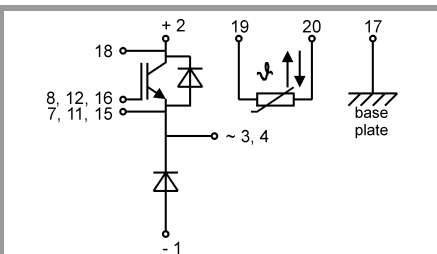

spring configuration

This is an electrostatic discharge sensitive device (ESDS), international standard IEC 60747-1, Chapter IX

\* The specifications of our components may not be considered as an assurance of component characteristics. Components have to be tested for the respective application. Adjustments may be necessary. The use of SEMIKRON products in life support appliances and systems is subject to prior specification and written approval by SEMIKRON. We therefore strongly recommend prior consultation of our staff.