



5STP 17F2201

Old part no. TV 918-1670-22

Phase Control Thyristor

Properties

- High operational capability
- Possibility of serial and parallel connection

Applications

- Controlled rectifiers
- AC drives

Key Parameters

V_{DRM}, V_{RRM}	= 2 200	V
I_{TAVm}	= 1 702	A
I_{TSM}	= 25 500	A
V_{TO}	= 0.992	V
r_T	= 0.206	mΩ

Types

	V_{RRM}, V_{DRM}
5STP 17F2201	2 200 V
Conditions:	$T_j = -40 \div 125 \text{ }^\circ\text{C}$, half sine waveform, $f = 50 \text{ Hz}$

Mechanical Data

F_m	Mounting force	22 ± 2 kN
m	Weight	0.48 kg
D_s	Surface creepage distance	25 mm
D_a	Air strike distance	13 mm

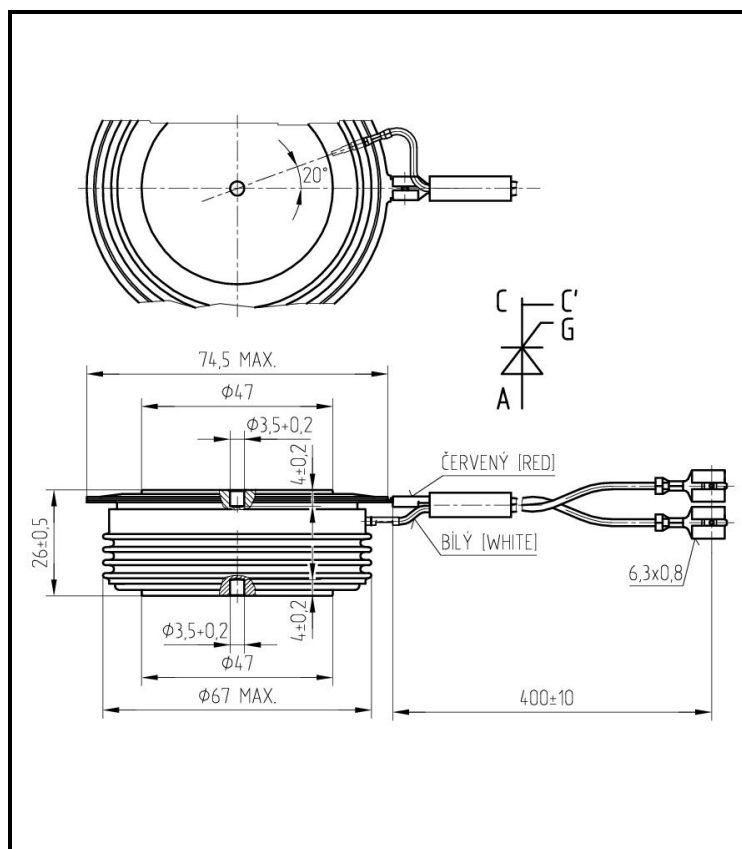

Fig. 1 Case



ABB s.r.o.

Novodvorska 1768/138a, 142 21 Praha 4, Czech Republic

tel.: +420 261 306 250, <http://www.abb.com/semiconductors>

Maximum Ratings		Maximum Limits	Unit
V_{RRM} V_{DRM}	Repetitive peak reverse and off-state voltage $T_j = -40 \div 125 \text{ }^\circ\text{C}$	2 200	V
I_{TRMS}	RMS on-state current $T_c = 70 \text{ }^\circ\text{C}$, half sine waveform, $f = 50 \text{ Hz}$	2 674	A
I_{TAVm}	Average on-state current $T_c = 70 \text{ }^\circ\text{C}$, half sine waveform, $f = 50 \text{ Hz}$	1 702	A
I_{TSM}	Peak non-repetitive surge half sine pulse, $V_R = 0 \text{ V}$	$t_p = 10 \text{ ms}$ 25 500 $t_p = 8.3 \text{ ms}$ 27 200	A
I^2t	Limiting load integral half sine pulse, $V_R = 0 \text{ V}$	$t_p = 10 \text{ ms}$ 3 251 250 $t_p = 8.3 \text{ ms}$ 3 070 000	A²s
$(di_T/dt)_{cr}$	Critical rate of rise of on-state current $I_T = I_{TAVm}$, half sine waveform, $f = 50 \text{ Hz}$, $V_D = 2/3 V_{DRM}$, $t_r = 0.3 \text{ } \mu\text{s}$, $I_{GT} = 2 \text{ A}$	200	A/μs
$(dv_D/dt)_{cr}$	Critical rate of rise of off-state voltage $V_D = 2/3 V_{DRM}$	1 000	V/μs
P_{GAVm}	Maximum average gate power losses	3	W
I_{FGM}	Peak gate current	10	A
V_{FGM}	Peak gate voltage	12	V
V_{RGM}	Reverse peak gate voltage	10	V
$T_{jmin} - T_{jmax}$	Operating temperature range	-40 \div 125	$^\circ\text{C}$
$T_{stgmin} - T_{stgmax}$	Storage temperature range	-40 \div 125	$^\circ\text{C}$

Unless otherwise specified $T_j = 125 \text{ }^\circ\text{C}$

Characteristics		Value			Unit
		min.	typ.	max.	
V_{TM}	Maximum peak on-state voltage $I_{TM} = 2\ 000\ A$			1.430	V
V_{T0}	Threshold voltage			0.992	V
r_T	Slope resistance $I_{T1} = 2\ 113\ A, I_{T2} = 6\ 338\ A$			0.206	m Ω
I_{DM}	Peak off-state current $V_D = V_{DRM}$			150	mA
I_{RM}	Peak reverse current $V_R = V_{RRM}$			150	mA
t_{gd}	Delay time $T_j = 25\ ^\circ C, V_D = 0.4\ V_{DRM}, I_{TM} = I_{TAVm},$ $t_r = 0.3\ \mu s, I_{GT} = 2\ A$			2	μs
t_q	Turn-off time $I_T = 2\ 000\ A, di_T/dt = 12.5\ A/\mu s,$ $V_D = 2/3\ V_{DRM}, dv_D/dt = 50\ V/\mu s$		200		μs
Q_{rr}	Recovery charge the same conditions as at t_q		2 600		μC
I_H	Holding current	$T_j = 25\ ^\circ C$ $T_j = 125\ ^\circ C$		170 90	mA
I_L	Latching current	$T_j = 25\ ^\circ C$ $T_j = 125\ ^\circ C$		450 350	mA
V_{GT}	Gate trigger voltage $V_D = 12V, I_T = 4\ A$	$T_j = -40\ ^\circ C$ $T_j = 25\ ^\circ C$ $T_j = 125\ ^\circ C$	0.25	4 3 2	V
I_{GT}	Gate trigger current $V_D = 12V, I_T = 4\ A$	$T_j = -40\ ^\circ C$ $T_j = 25\ ^\circ C$ $T_j = 125\ ^\circ C$	10	500 250 150	mA

Unless otherwise specified $T_j = 125\ ^\circ C$

Thermal Parameters		Value	Unit
R_{thjc}	Thermal resistance junction to case double side cooling	16.0	K/kW
	anode side cooling	25.0	
	cathode side cooling	45.0	
R_{thch}	Thermal resistance case to heatsink double side cooling	4.0	K/kW
	single side cooling	8.0	

ABB s.r.o., Novodvorska 1768/138a, 142 21 Praha 4, Czech Republic

Transient Thermal Impedance

Analytical function for transient thermal impedance

$$Z_{thjc} = \sum_{i=1}^4 R_i (1 - \exp(-t / \tau_i))$$

Conditions:

$F_m = 22 \pm 2$ kN, Double side cooled

Correction for periodic waveforms

- 180° sine: add 1.3 K/kW
- 180° rectangular: add 1.8 K/kW
- 120° rectangular: add 3.0 K/kW
- 60° rectangular: add 5.1 K/kW

i	1	2	3	4
τ_i (s)	0.4653	0.1533	0.0375	0.0034
R_i (K/kW)	5.50	7.24	2.00	1.34

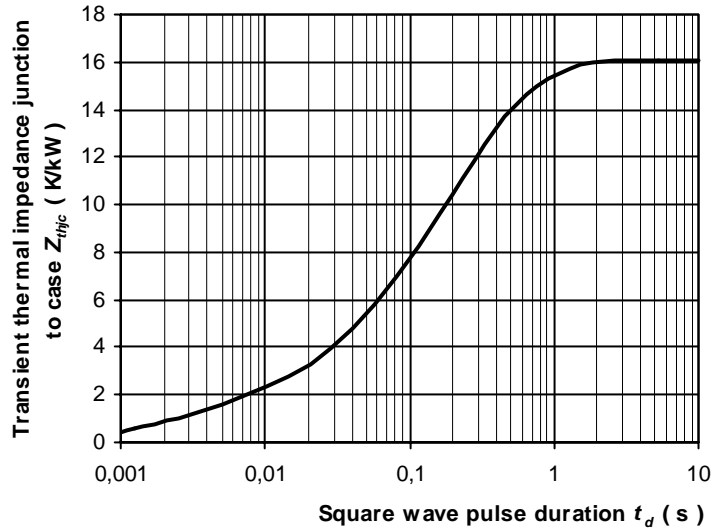

Fig. 2 Dependence transient thermal impedance junction to case on square pulse

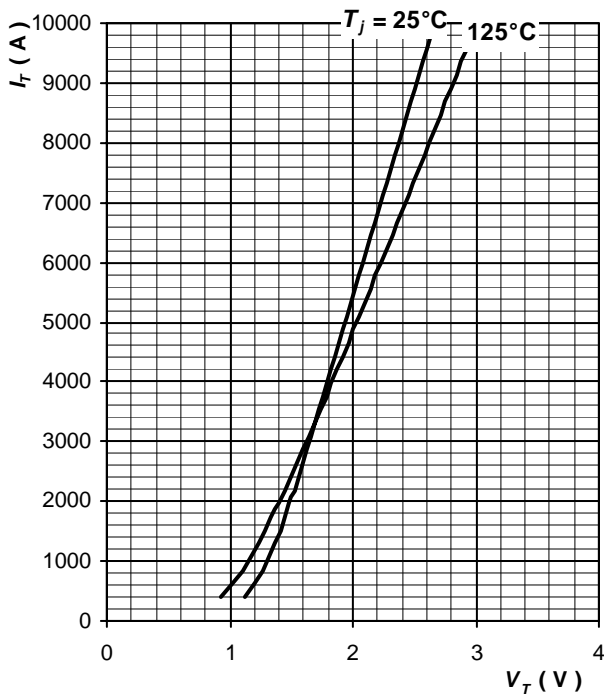

Fig. 3 Maximum on-state characteristics

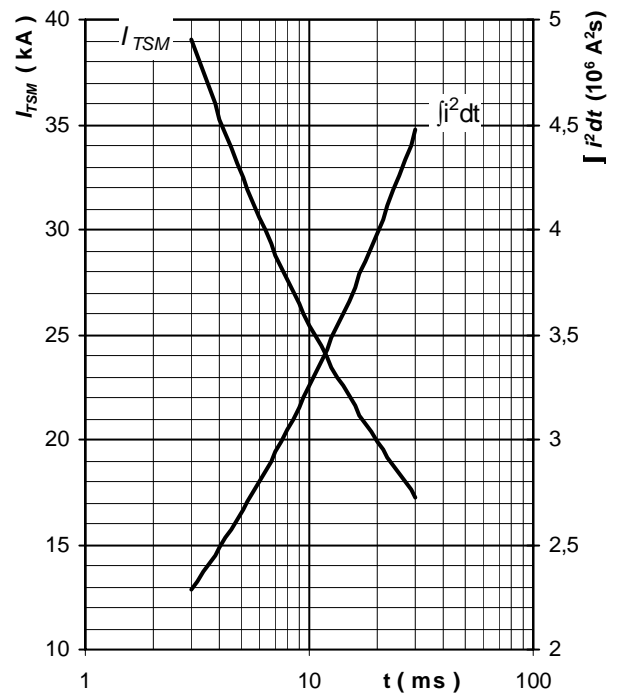

Fig. 4 Surge on-state current vs. pulse length, half sine wave, single pulse, $V_R = 0$ V, $T_j = T_{jmax}$

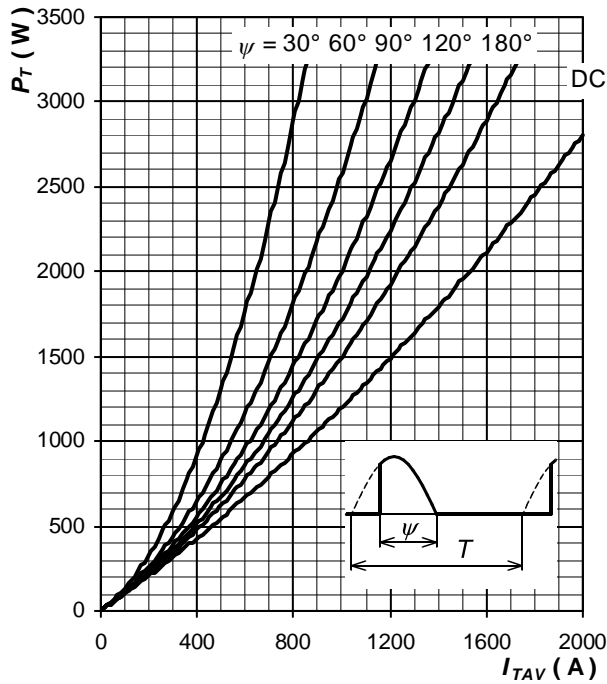

Fig. 5 On-state power loss vs. average on-state current, sine waveform, $f = 50 \text{ Hz}$, $T = 1/f$

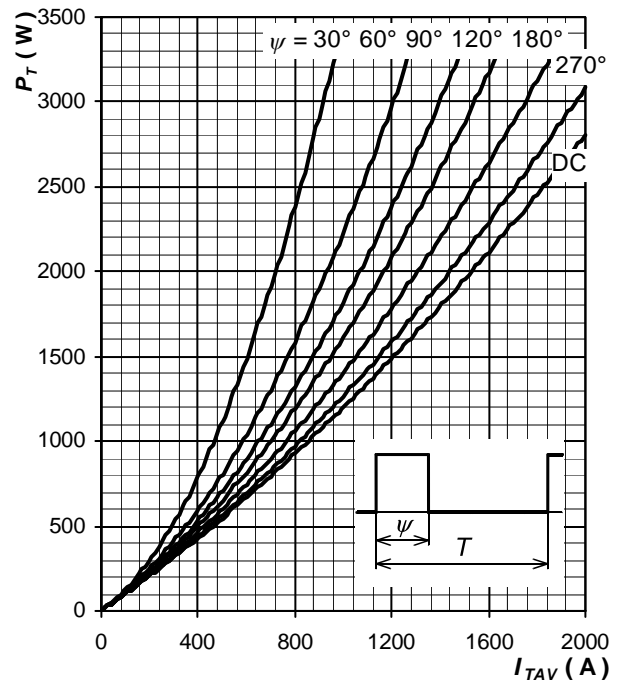

Fig. 6 On-state power loss vs. average on-state current, square waveform, $f = 50 \text{ Hz}$, $T = 1/f$

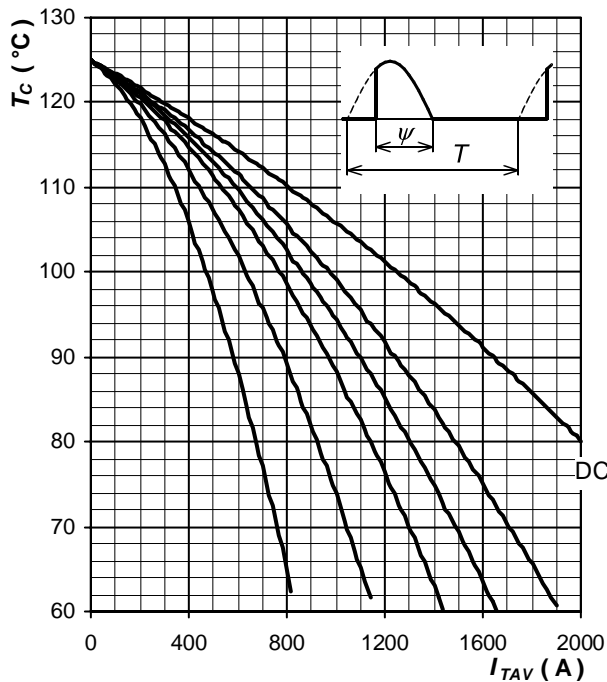

Fig. 7 Max. case temperature vs. aver. on-state current, sine waveform, $f = 50 \text{ Hz}$, $T = 1/f$

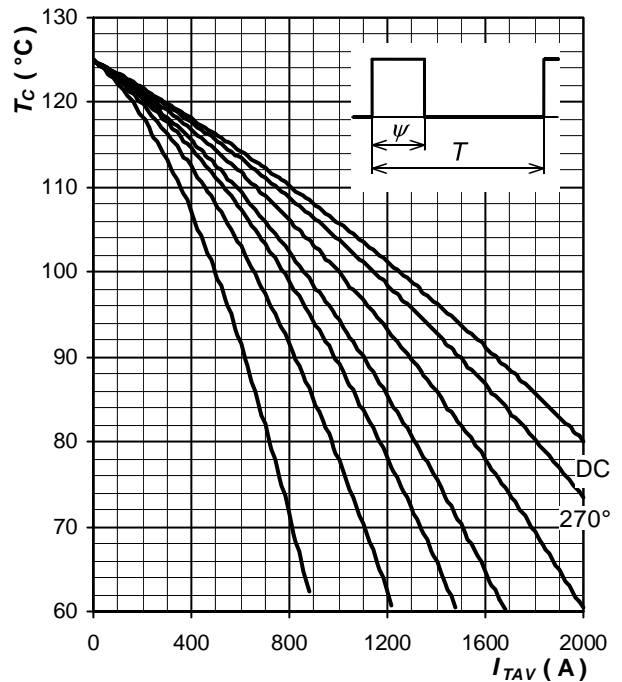

Fig. 8 Max. case temperature vs. aver. on-state current, square waveform, $f = 50 \text{ Hz}$, $T = 1/f$

Notes: