

Standard Rectifier Module

$$\begin{aligned} V_{RRM} &= 2 \times 800 \text{ V} \\ I_{FAV} &= 190 \text{ A} \\ V_F &= 0.96 \text{ V} \end{aligned}$$

Phase leg

Part number

MDD172-08N1

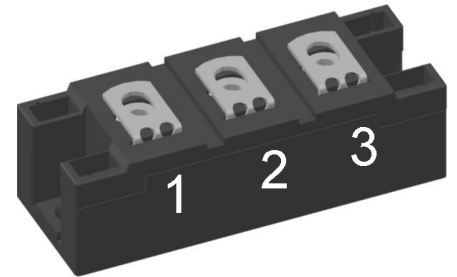

Backside: isolated

 E72873

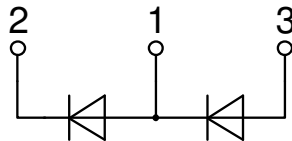

Features / Advantages:

- Package with DCB ceramic
- Improved temperature and power cycling
- Planar passivated chips
- Very low forward voltage drop
- Very low leakage current

Applications:

- Diode for main rectification
- For single and three phase bridge configurations
- Supplies for DC power equipment
- Input rectifiers for PWM inverter
- Battery DC power supplies
- Field supply for DC motors

Package: Y4

- Isolation Voltage: 3600 V~
- Industry standard outline
- RoHS compliant
- Soldering pins for PCB mounting
- Base plate: DCB ceramic
- Reduced weight
- Advanced power cycling

Terms Conditions of usage:

The data contained in this product data sheet is exclusively intended for technically trained staff. The user will have to evaluate the suitability of the product for the intended application and the completeness of the product data with respect to his application. The specifications of our components may not be considered as an assurance of component characteristics. The information in the valid application- and assembly notes must be considered. Should you require product information in excess of the data given in this product data sheet or which concerns the specific application of your product, please contact your local sales office.

Due to technical requirements our product may contain dangerous substances. For information on the types in question please contact your local sales office.

Should you intend to use the product in aviation, in health or life endangering or life support applications, please notify. For any such application we urgently recommend

- to perform joint risk and quality assessments;

- the conclusion of quality agreements;

- to establish joint measures of an ongoing product survey, and that we may make delivery dependent on the realization of any such measures.

| Rectifier | | | | Ratings | | | |
|--------------|--|---|-------------------------|---------|-------|-------------------|--|
| Symbol | Definition | Conditions | min. | typ. | max. | Unit | |
| V_{RSM} | max. non-repetitive reverse blocking voltage | $T_{VJ} = 25^{\circ}C$ | | | 900 | V | |
| V_{RRM} | max. repetitive reverse blocking voltage | $T_{VJ} = 25^{\circ}C$ | | | 800 | V | |
| I_R | reverse current | $V_R = 800 V$ | $T_{VJ} = 25^{\circ}C$ | | 1 | mA | |
| | | $V_R = 800 V$ | $T_{VJ} = 150^{\circ}C$ | | 20 | mA | |
| V_F | forward voltage drop | $I_F = 150 A$ | $T_{VJ} = 25^{\circ}C$ | | 1.07 | V | |
| | | $I_F = 300 A$ | | | 1.22 | V | |
| | | $I_F = 150 A$ | $T_{VJ} = 125^{\circ}C$ | | 0.96 | V | |
| | | $I_F = 300 A$ | | | 1.16 | V | |
| I_{FAV} | average forward current | $T_C = 100^{\circ}C$ | $T_{VJ} = 150^{\circ}C$ | | 190 | A | |
| $I_{F(RMS)}$ | RMS forward current | 180° sine | | | 300 | A | |
| V_{F0} | threshold voltage | } for power loss calculation only | $T_{VJ} = 150^{\circ}C$ | | 0.80 | V | |
| r_F | slope resistance | | | | 0.8 | mΩ | |
| R_{thJC} | thermal resistance junction to case | | | | 0.21 | K/W | |
| R_{thCH} | thermal resistance case to heatsink | | | 0.08 | | K/W | |
| P_{tot} | total power dissipation | | $T_C = 25^{\circ}C$ | | 600 | W | |
| I_{FSM} | max. forward surge current | $t = 10 \text{ ms}; (50 \text{ Hz}), \text{ sine}$ | $T_{VJ} = 45^{\circ}C$ | | 6.60 | kA | |
| | | $t = 8,3 \text{ ms}; (60 \text{ Hz}), \text{ sine}$ | $V_R = 0 V$ | | 7.13 | kA | |
| | | $t = 10 \text{ ms}; (50 \text{ Hz}), \text{ sine}$ | $T_{VJ} = 150^{\circ}C$ | | 5.61 | kA | |
| | | $t = 8,3 \text{ ms}; (60 \text{ Hz}), \text{ sine}$ | $V_R = 0 V$ | | 6.06 | kA | |
| I^2t | value for fusing | $t = 10 \text{ ms}; (50 \text{ Hz}), \text{ sine}$ | $T_{VJ} = 45^{\circ}C$ | | 217.8 | kA ² s | |
| | | $t = 8,3 \text{ ms}; (60 \text{ Hz}), \text{ sine}$ | $V_R = 0 V$ | | 211.5 | kA ² s | |
| | | $t = 10 \text{ ms}; (50 \text{ Hz}), \text{ sine}$ | $T_{VJ} = 150^{\circ}C$ | | 157.4 | kA ² s | |
| | | $t = 8,3 \text{ ms}; (60 \text{ Hz}), \text{ sine}$ | $V_R = 0 V$ | | 152.8 | kA ² s | |
| C_J | junction capacitance | $V_R = 400 V; f = 1 \text{ MHz}$ | $T_{VJ} = 25^{\circ}C$ | | 238 | pF | |

| Package Y4 | | | | Ratings | | | |
|---------------|--|----------------------|-------------------------------------|---------|------|------|--|
| Symbol | Definition | Conditions | min. | typ. | max. | Unit | |
| I_{RMS} | RMS current | per terminal | | | 300 | A | |
| T_{VJ} | virtual junction temperature | | -40 | | 150 | °C | |
| T_{op} | operation temperature | | -40 | | 125 | °C | |
| T_{stg} | storage temperature | | -40 | | 125 | °C | |
| Weight | | | | 150 | | g | |
| M_D | mounting torque | | 2.25 | | 2.75 | Nm | |
| M_T | terminal torque | | 4.5 | | 5.5 | Nm | |
| $d_{Spp/App}$ | creepage distance on surface striking distance through air | terminal to terminal | 14.0 | 10.0 | | mm | |
| $d_{Spb/Apb}$ | | terminal to backside | 16.0 | 16.0 | | mm | |
| V_{ISOL} | isolation voltage | t = 1 second | | | 3600 | V | |
| | | t = 1 minute | 50/60 Hz, RMS; $I_{ISOL} \leq 1$ mA | | 3000 | V | |

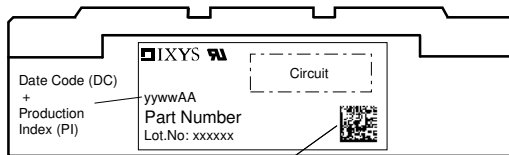

Data Matrix: part no. (1-19), DC + PI (20-25), lot.no.# (26-31), blank (32), serial no.# (33-36)

| Ordering | Ordering Number | Marking on Product | Delivery Mode | Quantity | Code No. |
|----------|-----------------|--------------------|---------------|----------|----------|
| Standard | MDD172-08N1 | MDD172-08N1 | Box | 6 | 429694 |

Equivalent Circuits for Simulation

* on die level

$T_{VJ} = 150^\circ\text{C}$



Rectifier

| | | | |
|--------------|--------------------|-----|----|
| $V_{0 \max}$ | threshold voltage | 0.8 | V |
| $R_{0 \max}$ | slope resistance * | 0.4 | mΩ |

Outlines Y4

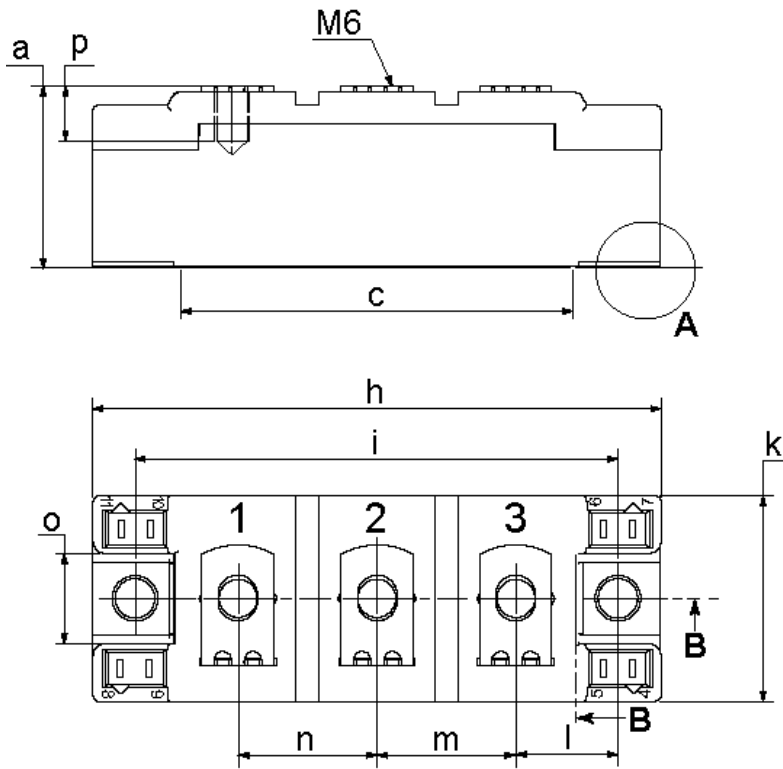

| Dim. | MIN [mm] | MAX [mm] | MIN [inch] | MAX [inch] |
|------|-----------|----------|------------|------------|
| a | 30.0 | 30.6 | 1.181 | 1.205 |
| b | typ. 0.25 | | typ. 0.010 | |
| c | 64.0 | 65.0 | 2.520 | 2.559 |
| d | 6.5 | 7.0 | 0.256 | 0.275 |
| e | 4.9 | 5.1 | 0.193 | 0.201 |
| h | 93.5 | 94.5 | 3.681 | 3.720 |
| i | 79.5 | 80.5 | 3.130 | 3.169 |
| k | 33.4 | 34.0 | 1.315 | 1.339 |
| l | 16.7 | 17.3 | 0.657 | 0.681 |
| m | 22.7 | 23.3 | 0.894 | 0.917 |
| n | 22.7 | 23.3 | 0.894 | 0.917 |
| o | 14.0 | 15.0 | 0.551 | 0.591 |
| p | typ. 10.5 | | typ. 0.413 | |

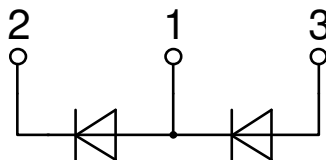
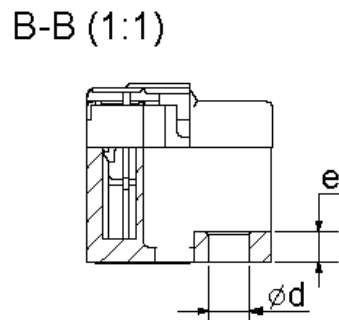
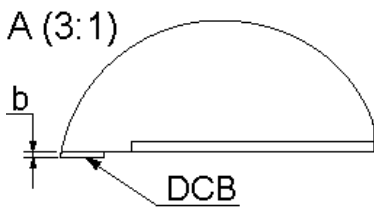

Rectifier

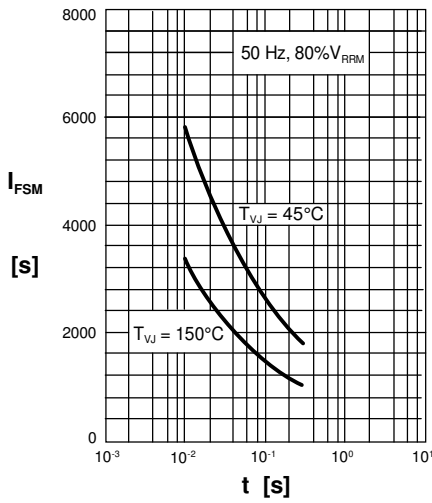

Fig. 1 Surge overload current
 I_{FSM} : Crest value, t: duration

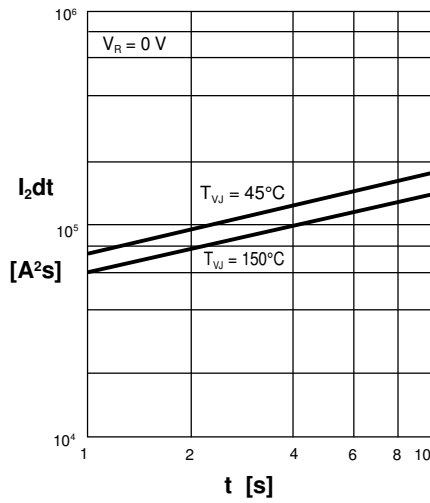

Fig. 2 I_2dt versus time (1-10 ms)

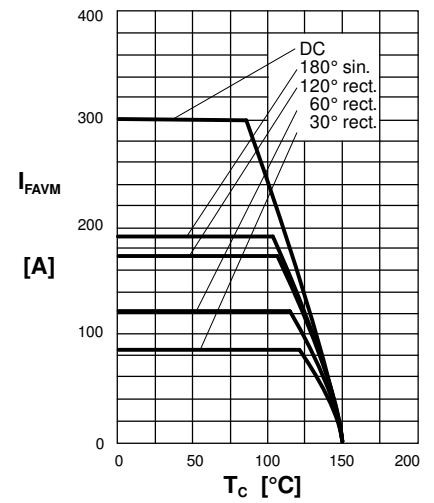

Fig. 2a Maximum forward current at case temperature

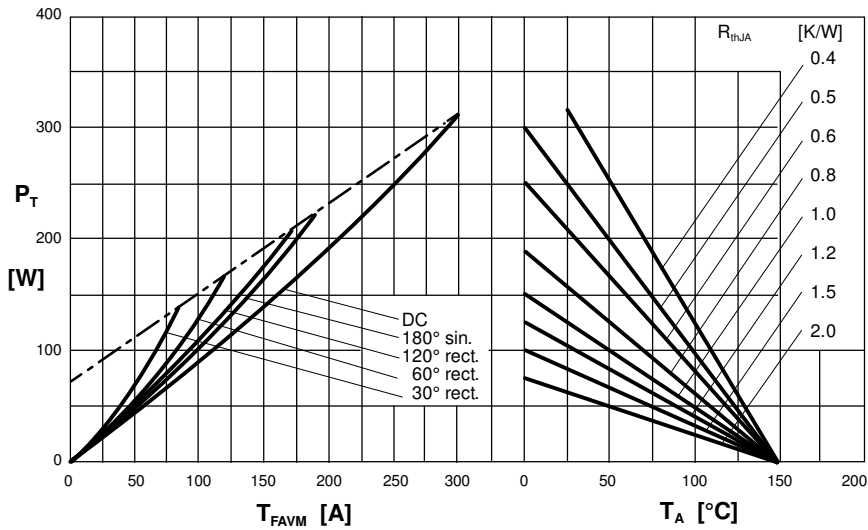

Fig. 3 Power dissipation vs. forward current and ambient temperature (per diode)

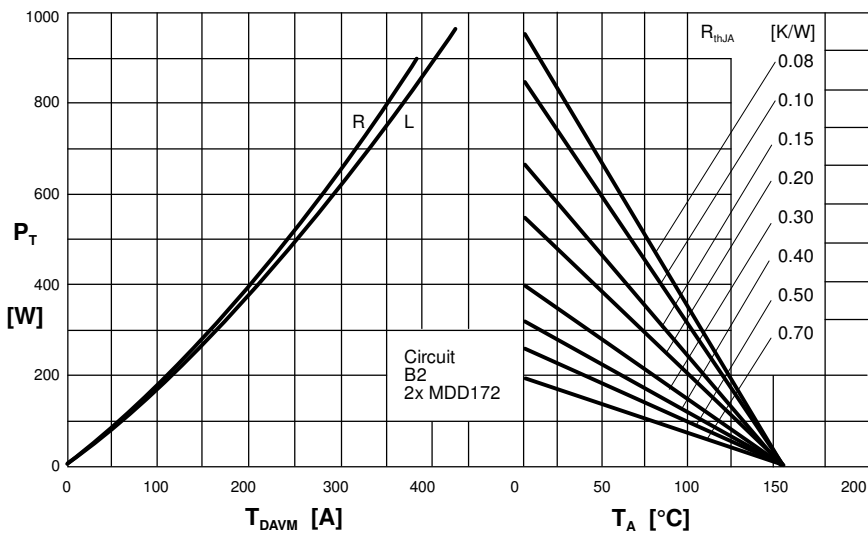

Fig. 4 Single phase rectifier bridge: Power dissipation vs. direct output current and ambient

R = resistive load
L = inductive load

Rectifier

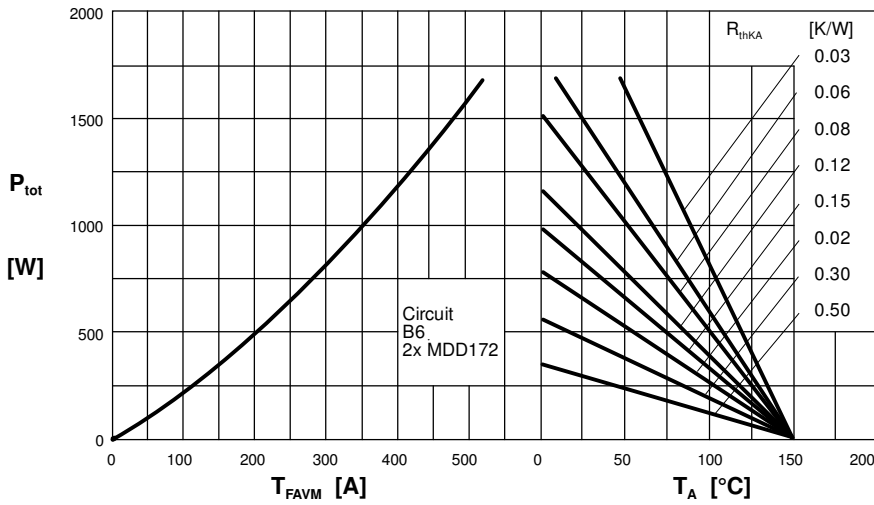

Fig. 5 Three phase rectifier bridge: Power dissipation vs. direct output current and ambient temperature

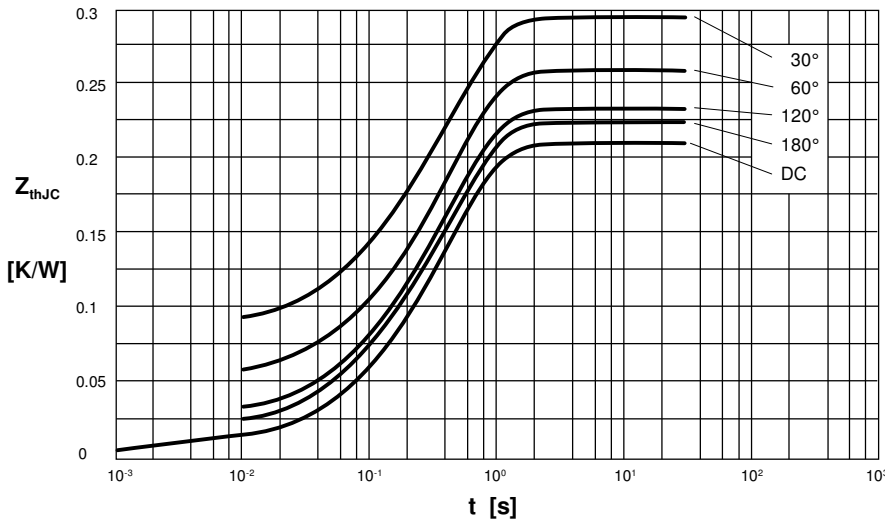

Fig. 6 Transient thermal impedance junction to case (per diode)

R_{thJC} for various conduction angles d :

| d | R_{thJC} [K/W] |
|------|------------------|
| DC | 0.210 |
| 180° | 0.223 |
| 120° | 0.233 |
| 60° | 0.260 |
| 30° | 0.295 |

Constants for Z_{thJC} calculation:

| i | R_{thi} [K/W] | t_i [s] |
|-----|-----------------|-----------|
| 1 | 0.0087 | 0.001 |
| 2 | 0.0163 | 0.065 |
| 3 | 0.1850 | 0.400 |

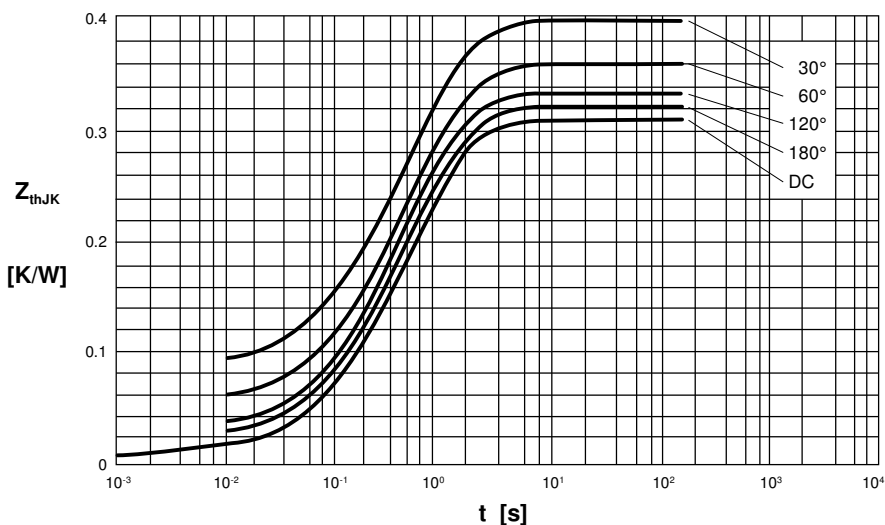

Fig. 7 Transient thermal impedance junction to heatsink (per diode)

R_{thJK} for various conduction angles d :

| d | R_{thJK} [K/W] |
|------|------------------|
| DC | 0.310 |
| 180° | 0.323 |
| 120° | 0.333 |
| 60° | 0.360 |
| 30° | 0.395 |

Constants for Z_{thJK} calculation:

| i | R_{thi} [K/W] | t_i [s] |
|-----|-----------------|-----------|
| 1 | 0.0087 | 0.001 |
| 2 | 0.0163 | 0.065 |
| 3 | 0.1850 | 0.400 |
| 4 | 0.1000 | 1.290 |