

Thyristor Modules

Thyristor/Diode Modules

 $I_{TRMS} = 2x 180 A$
 $I_{TAVM} = 2x 116 A$
 $V_{RRM} = 800-1800 V$

V_{RSM}	V_{RRM}	Type					
V_{DSM}	V_{DRM}		1B	8B	Version	1B	8B
V	V	Version					
900	800	MCC 95-08	io1B / io8B		MCD 95-08	io1B / io8B	
1300	1200	MCC 95-12	io1B / io8B		MCD 95-12	io1B / io8B	
1500	1400	MCC 95-14	io1B / io8B		MCD 95-14	io1B / io8B	
1700	1600	MCC 95-16	io1B / io8B		MCD 95-16	io1B / io8B	
1900	1800	MCC 95-18	io1B / io8B		MCD 95-18	io1B / io8B	

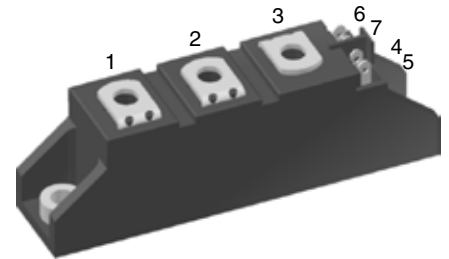

Symbol	Conditions	Maximum Ratings	
I_{TRMS}, I_{FRMS} I_{TAVM}, I_{FAVM}	$T_{VJ} = T_{VJM}$ $T_C = 85^\circ C; 180^\circ$ sine	180	A
		116	A
I_{TSM}, I_{FSM}	$T_{VJ} = 45^\circ C$ $V_R = 0$	$t = 10$ ms (50 Hz) $t = 8.3$ ms (60 Hz)	2250 A 2400 A
	$T_{VJ} = T_{VJM}$ $V_R = 0$	$t = 10$ ms (50 Hz) $t = 8.3$ ms (60 Hz)	2000 A 2150 A
I^2t	$T_{VJ} = 45^\circ C$ $V_R = 0$	$t = 10$ ms (50 Hz) $t = 8.3$ ms (60 Hz)	25 300 A ² s 23 900 A ² s
	$T_{VJ} = T_{VJM}$ $V_R = 0$	$t = 10$ ms (50 Hz) $t = 8.3$ ms (60 Hz)	20 000 A ² s 19 100 A ² s
$(di/dt)_{cr}$	$T_{VJ} = T_{VJM}$ $f = 50$ Hz; $t_p = 200$ μ s; $V_D = 2/3 V_{DRM}$ $I_G = 0.45$ A $di_G/dt = 0.45$ A/ μ s	repetitive, $I_T = 250$ A non repetitive, $I_T = I_{TAVM}$	150 A/ μ s 500 A/ μ s
$(dv/dt)_{cr}$	$T_{VJ} = T_{VJM}; V_D = 2/3 V_{DRM}$ $R_{GK} = \infty$; method 1 (linear voltage rise)		1000 V/ μ s
P_{GM}	$T_{VJ} = T_{VJM}; t_p = 30$ μ s $I_T = I_{T(AV)M}; t_p = 500$ μ s		10 W 5 W
P_{GAV}			0.5 W
V_{RGM}			10 V
T_{VJ}			-40...+125 $^\circ C$
T_{VJM}			125 $^\circ C$
T_{stg}			-40...+125 $^\circ C$
V_{ISOL}	50/60 Hz, RMS $I_{ISOL} \leq 1$ mA	$t = 1$ min $t = 1$ s	3000 V~ 3600 V~
M_d	Mounting torque (M5) Terminal connection torque (M5)		2.5 - 4 Nm 2.5 - 4 Nm
Weight	Typical including screws		85 g

Data according to IEC 60747 and refer to a single diode unless otherwise stated.

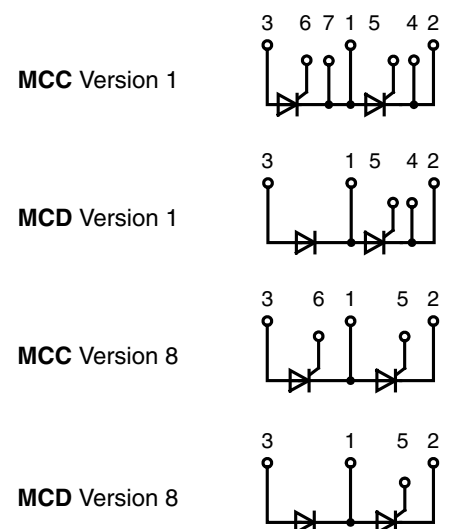

Features

- International standard package, JEDEC TO-240 AA
- Direct copper bonded Al_2O_3 -ceramic base plate
- Planar passivated chips
- Isolation voltage 3600 V~
- UL registered, E 72873
- Gate-cathode twin pins for version 1

Applications

- DC Motor control
- Softstart AC motor controller
- Light, heat and temperature control

Advantages

- Space and weight savings
- Simple mounting with two screws
- Improved temperature & power cycling
- Reduced protection circuits

Symbol	Conditions	Characteristic Values	
		typ.	max.
I_{RRM}, I_{DRM}	$V_R / V_D = V_{RRM} / V_{DRM}$	$T_{VJ} = T_{VJM}$	5 mA
V_T, V_F	$I_T / I_F = 300$ A	$T_{VJ} = 25^\circ\text{C}$	1.5 V
V_{T0}	For power-loss calculations only		0.8 V
r_t		$T_{VJ} = T_{VJM}$	2.4 mΩ
V_{GT}	$V_D = 6$ V	$T_{VJ} = 25^\circ\text{C}$ $T_{VJ} = -40^\circ\text{C}$	2.5 V 2.6 V
I_{GT}	$V_D = 6$ V	$T_{VJ} = 25^\circ\text{C}$ $T_{VJ} = -40^\circ\text{C}$	150 mA 200 mA
V_{GD}	$V_D = 2/3 V_{DRM}$	$T_{VJ} = T_{VJM}$	0.2 V
I_{GD}			10 mA
I_L	$t_p = 10 \mu\text{s}; V_D = 6$ V $I_G = 0.45$ A; $di_G/dt = 0.45$ A/ μs	$T_{VJ} = 25^\circ\text{C}$	450 mA
I_H	$V_D = 6$ V; $R_{GK} = \infty$;	$T_{VJ} = 25^\circ\text{C}$	200 mA
t_{gd}	$V_D = 1/2 V_{DRM}$ $I_G = 0.45$ A; $di_G/dt = 0.45$ A/ μs	$T_{VJ} = 25^\circ\text{C}$	2 μs
t_q	$V_D = 2/3 V_{DRM}$ $dv/dt = 20$ V/ μs ; $-di/dt = 10$ A/ μs $I_T = 150$ A; $V_R = 100$ V; $t_p = 200 \mu\text{s}$	$T_{VJ} = T_{VJM}$	185 μs
Q_S	$I_T / I_F = 50$ A; $-di/dt = 6$ A/ μs	$T_{VJ} = T_{VJM}$	170 μC
I_{RM}			45 A
R_{thJC}	per thyristor; DC current per module	} other values see Fig. 8/9	0.22 K/W
R_{thJK}	per thyristor; DC current per module		0.11 K/W
			0.42 K/W
			0.21 K/W
d_s	Creeping distance on surface		12.7 mm
d_A	Creepage distance in air		9.6 mm
a	Maximum allowable acceleration		50 m/s ²

Optional accessories for modules

Coded gate/cathode twin plugs with wire length = 350 mm, gate = yellow, cathode = red

Type **ZY 200L** (L = Left for pin pair 4/5) } UL 758, style 1385,
 Type **ZY 200R** (R = Right for pin pair 6/7) } CSA class 5851, guide 460-1-1

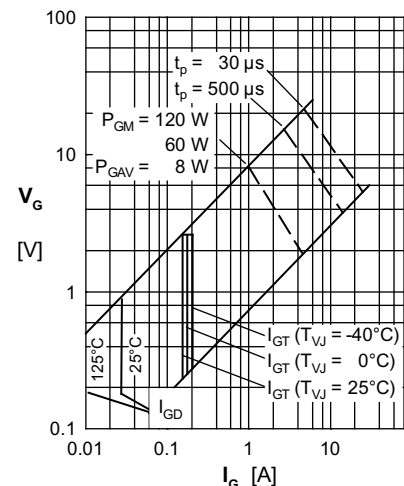

Fig. 1 Gate trigger characteristics



Fig. 2 Gate trigger delay time

Dimensions in mm (1 mm = 0.0394")

MCC... Version 1B

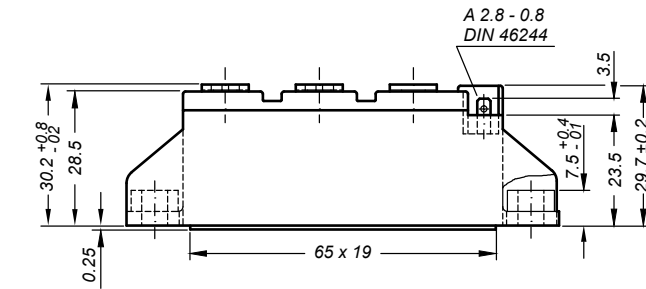

General tolerance: DIN ISO 2768 class „c“

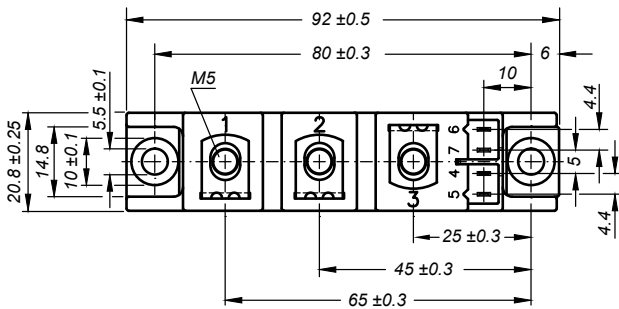

Optional accessories: Keyed gate/cathode twin plugs
Wire length: 350 mm, gate = yellow, cathode = red
UL 758, style 1385, CSA class 5851, guide 460-1-1
Type ZY 200L (L = Left for pin pair 4/5)
Type ZY 200R (R = Right for pin pair 6/7)

MCD... Version 1B

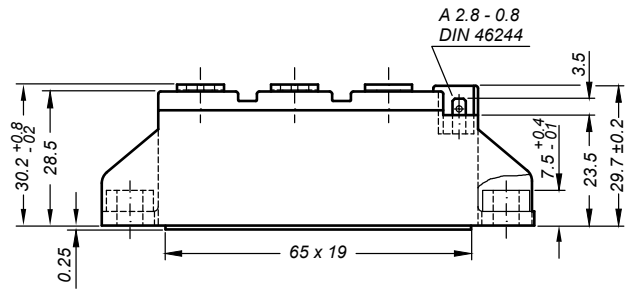

General tolerance: DIN ISO 2768 class „c“

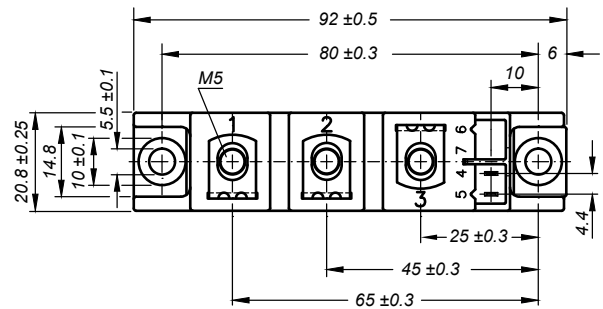

Optional accessories: Keyed gate/cathode twin plugs
Wire length: 350 mm, gate = yellow, cathode = red
UL 758, style 1385, CSA class 5851, guide 460-1-1
Type ZY 200L (L = Left for pin pair 4/5)

MCC... Version 8B

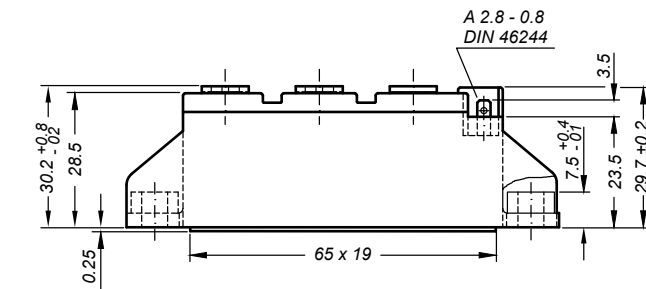

General tolerance: DIN ISO 2768 class „c“

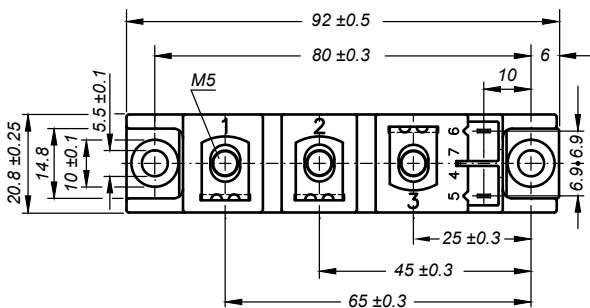

MCD... Version 8B

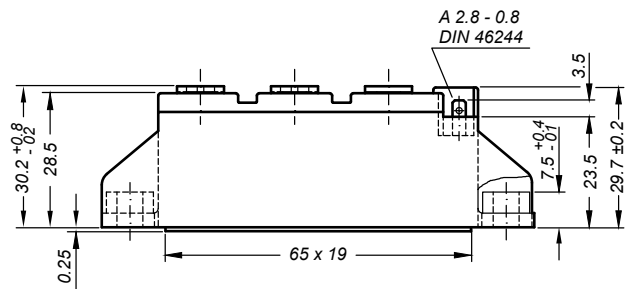

General tolerance: DIN ISO 2768 class „c“

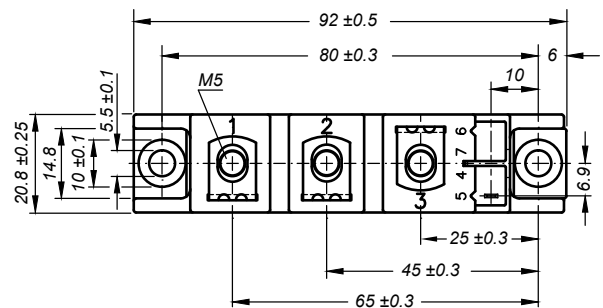



Fig. 3 Surge overload current I_{TSM} ,
 I_{FSM} : Crest value, t : duration



Fig. 4 I^2t versus time (1-10 ms)



Fig. 4a Maximum forward current
at case temperature



Fig. 5 Power dissipation versus
on-state current & ambient
temperature
(per thyristor or diode)

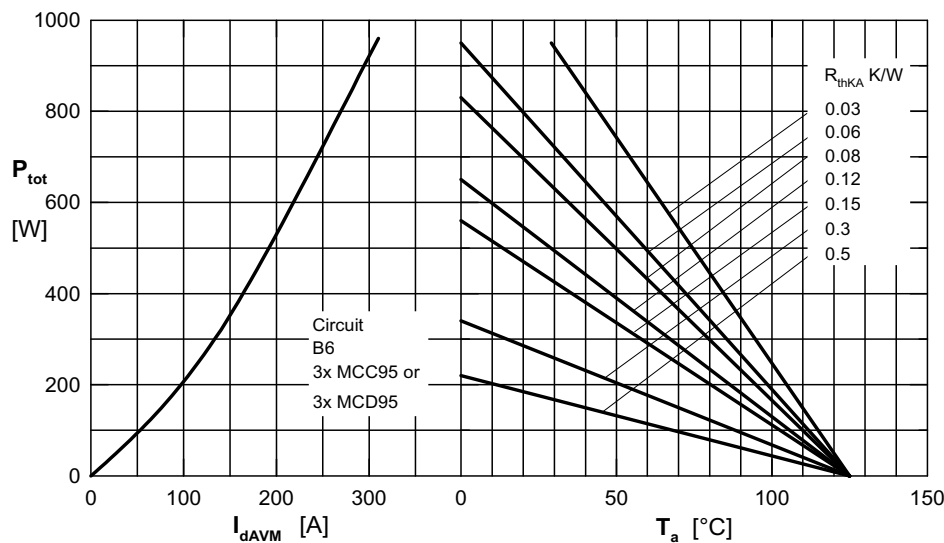

Fig. 6 Three phase rectifier bridge:
Power dissipation vs. direct
output current and ambient
temperature



Fig. 7 Three phase AC-controller: Power dissipation versus RMS output current and ambient temperature

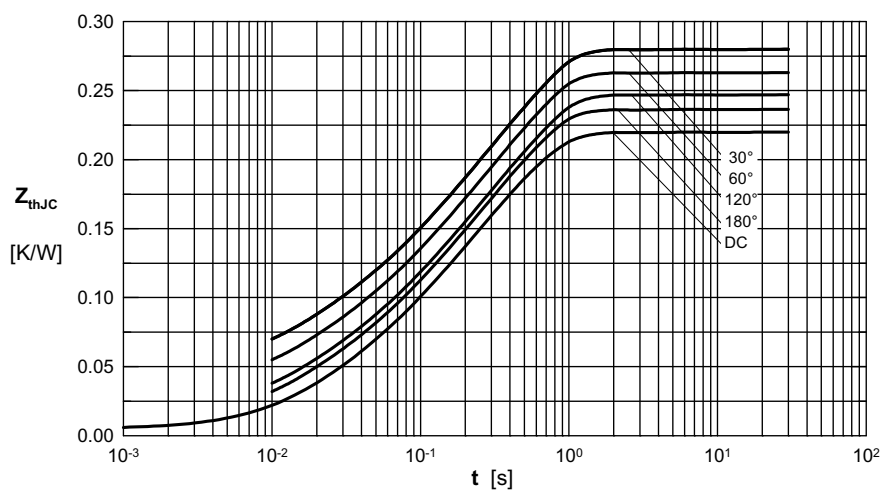

Fig. 8 Transient thermal impedance junction to case (per thyristor or diode)

R_{thJC} for various conduction angles d :

d	R_{thJC} (K/W)
DC	0.22
180°	0.23
120°	0.25
60°	0.27
30°	0.28

Constants for Z_{thJC} calculation:

i	R_{thi} (K/W)	t_i (s)
1	0.0066	0.0019
2	0.0678	0.0477
3	0.1456	0.344

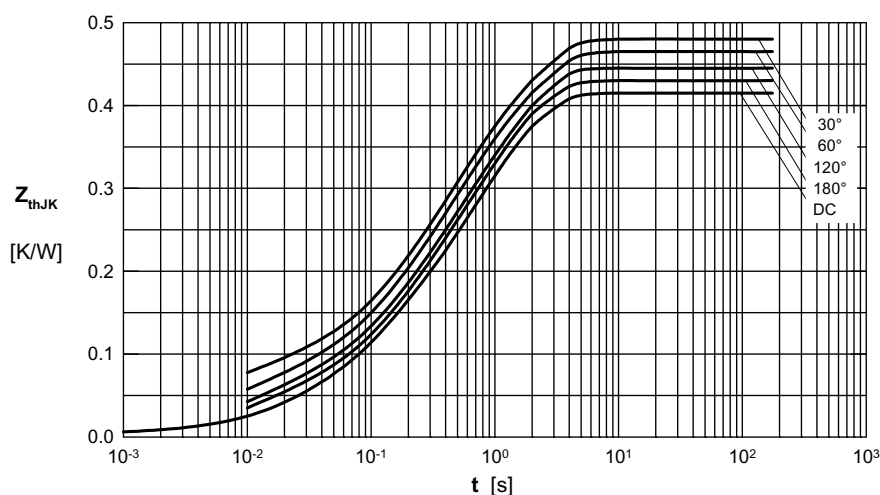

Fig. 9 Transient thermal impedance junction to heatsink (per thyristor or diode)

R_{thJK} for various conduction angles d :

d	R_{thJK} (K/W)
DC	0.42
180°	0.43
120°	0.45
60°	0.47
30°	0.48

Constants for Z_{thJK} calculation:

i	R_{thi} (K/W)	t_i (s)
1	0.0066	0.0019
2	0.0678	0.0477
3	0.1456	0.344
4	0.2	1.32

This datasheet has been downloaded from:

datasheet.eeworld.com.cn

Free Download

Daily Updated Database

100% Free Datasheet Search Site

100% Free IC Replacement Search Site

Convenient Electronic Dictionary

Fast Search System

www.EEworld.com.cn