

Thyristor \ Diode Module

$V_{RRM} = 2 \times 800 \text{ V}$
 $I_{TAV} = 85 \text{ A}$
 $V_T = 1.34 \text{ V}$

Phase leg

Part number

MCD72-08io8B

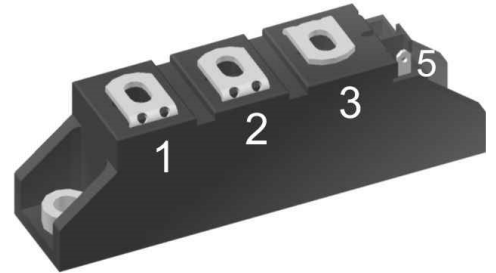

Backside: isolated

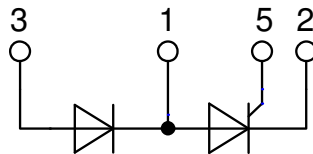
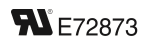

Features / Advantages:

- Thyristor for line frequency
- Planar passivated chip
- Long-term stability
- Direct Copper Bonded Al₂O₃-ceramic

Applications:

- Line rectifying 50/60 Hz
- Softstart AC motor control
- DC Motor control
- Power converter
- AC power control
- Lighting and temperature control

Package: TO-240AA

- Isolation Voltage: 3600 V~
- Industry standard outline
- RoHS compliant
- Soldering pins for PCB mounting
- Base plate: DCB ceramic
- Reduced weight
- Advanced power cycling

Terms Conditions of usage:

The data contained in this product data sheet is exclusively intended for technically trained staff. The user will have to evaluate the suitability of the product for the intended application and the completeness of the product data with respect to his application. The specifications of our components may not be considered as an assurance of component characteristics. The information in the valid application- and assembly notes must be considered. Should you require product information in excess of the data given in this product data sheet or which concerns the specific application of your product, please contact your local sales office.

Due to technical requirements our product may contain dangerous substances. For information on the types in question please contact your local sales office.

Should you intend to use the product in aviation, in health or life endangering or life support applications, please notify. For any such application we urgently recommend

- to perform joint risk and quality assessments;

- the conclusion of quality agreements;

- to establish joint measures of an ongoing product survey, and that we may make delivery dependent on the realization of any such measures.

| Rectifier | | | Ratings | | | |
|----------------|--|--|---------------------------|------|------|-------------------|
| Symbol | Definition | Conditions | min. | typ. | max. | Unit |
| $V_{RSM/DSM}$ | max. non-repetitive reverse/forward blocking voltage | $T_{VJ} = 25^{\circ}C$ | | | 900 | V |
| $V_{RRM/DRM}$ | max. repetitive reverse/forward blocking voltage | $T_{VJ} = 25^{\circ}C$ | | | 800 | V |
| I_{RD} | reverse current, drain current | $V_{R/D} = 800 V$ | $T_{VJ} = 25^{\circ}C$ | | 200 | μA |
| | | $V_{R/D} = 800 V$ | $T_{VJ} = 125^{\circ}C$ | | 5 | mA |
| V_T | forward voltage drop | $I_T = 150 A$ | $T_{VJ} = 25^{\circ}C$ | | 1.34 | V |
| | | $I_T = 300 A$ | | | 1.74 | V |
| | | $I_T = 150 A$ | $T_{VJ} = 125^{\circ}C$ | | 1.34 | V |
| | | $I_T = 300 A$ | | | 1.82 | V |
| I_{TAV} | average forward current | $T_C = 85^{\circ}C$ | $T_{VJ} = 125^{\circ}C$ | | 85 | A |
| $I_{T(RMS)}$ | RMS forward current | 180° sine | | | 133 | A |
| V_{T0} | threshold voltage | } for power loss calculation only | $T_{VJ} = 125^{\circ}C$ | | 0.85 | V |
| r_T | slope resistance | | | | 3.2 | m Ω |
| R_{thJC} | thermal resistance junction to case | | | | 0.3 | K/W |
| R_{thCH} | thermal resistance case to heatsink | | | 0.20 | | K/W |
| P_{tot} | total power dissipation | | $T_C = 25^{\circ}C$ | | 333 | W |
| I_{TSM} | max. forward surge current | $t = 10 \text{ ms}; (50 \text{ Hz}), \text{ sine}$ | $T_{VJ} = 45^{\circ}C$ | | 1.70 | kA |
| | | $t = 8,3 \text{ ms}; (60 \text{ Hz}), \text{ sine}$ | $V_R = 0 V$ | | 1.84 | kA |
| | | $t = 10 \text{ ms}; (50 \text{ Hz}), \text{ sine}$ | $T_{VJ} = 125^{\circ}C$ | | 1.45 | kA |
| | | $t = 8,3 \text{ ms}; (60 \text{ Hz}), \text{ sine}$ | $V_R = 0 V$ | | 1.56 | kA |
| I^2t | value for fusing | $t = 10 \text{ ms}; (50 \text{ Hz}), \text{ sine}$ | $T_{VJ} = 45^{\circ}C$ | | 14.5 | kA ² s |
| | | $t = 8,3 \text{ ms}; (60 \text{ Hz}), \text{ sine}$ | $V_R = 0 V$ | | 14.0 | kA ² s |
| | | $t = 10 \text{ ms}; (50 \text{ Hz}), \text{ sine}$ | $T_{VJ} = 125^{\circ}C$ | | 10.4 | kA ² s |
| | | $t = 8,3 \text{ ms}; (60 \text{ Hz}), \text{ sine}$ | $V_R = 0 V$ | | 10.1 | kA ² s |
| C_J | junction capacitance | $V_R = 400 V \quad f = 1 \text{ MHz}$ | $T_{VJ} = 25^{\circ}C$ | | 119 | pF |
| P_{GM} | max. gate power dissipation | $t_p = 30 \mu s$ | $T_C = 125^{\circ}C$ | | 10 | W |
| | | $t_p = 300 \mu s$ | | | 5 | W |
| P_{GAV} | average gate power dissipation | | | | 0.5 | W |
| $(di/dt)_{cr}$ | critical rate of rise of current | $T_{VJ} = 125^{\circ}C; f = 50 \text{ Hz}$ | repetitive, $I_T = 250 A$ | | 150 | A/ μs |
| | | $t_p = 200 \mu s; di_G/dt = 0.45 \text{ A}/\mu s;$ $I_G = 0.45 A; V = \frac{2}{3} V_{DRM}$ | non-repet., $I_T = 85 A$ | | 500 | A/ μs |
| $(dv/dt)_{cr}$ | critical rate of rise of voltage | $V = \frac{2}{3} V_{DRM}$ $R_{GK} = \infty; \text{ method 1 (linear voltage rise)}$ | $T_{VJ} = 125^{\circ}C$ | | 1000 | V/ μs |
| V_{GT} | gate trigger voltage | $V_D = 6 V$ | $T_{VJ} = 25^{\circ}C$ | | 2.5 | V |
| | | | $T_{VJ} = -40^{\circ}C$ | | 2.6 | V |
| I_{GT} | gate trigger current | $V_D = 6 V$ | $T_{VJ} = 25^{\circ}C$ | | 150 | mA |
| | | | $T_{VJ} = -40^{\circ}C$ | | 200 | mA |
| V_{GD} | gate non-trigger voltage | $V_D = \frac{2}{3} V_{DRM}$ | $T_{VJ} = 125^{\circ}C$ | | 0.2 | V |
| I_{GD} | gate non-trigger current | | | | 10 | mA |
| I_L | latching current | $t_p = 10 \mu s$ | $T_{VJ} = 25^{\circ}C$ | | 450 | mA |
| | | $I_G = 0.45 A; di_G/dt = 0.45 \text{ A}/\mu s$ | | | | |
| I_H | holding current | $V_D = 6 V \quad R_{GK} = \infty$ | $T_{VJ} = 25^{\circ}C$ | | 200 | mA |
| t_{gd} | gate controlled delay time | $V_D = \frac{1}{2} V_{DRM}$ | $T_{VJ} = 25^{\circ}C$ | | 2 | μs |
| | | $I_G = 0.45 A; di_G/dt = 0.45 \text{ A}/\mu s$ | | | | |
| t_q | turn-off time | $V_R = 100 V; I_T = 150 A; V = \frac{2}{3} V_{DRM}$ $di/dt = 10 \text{ A}/\mu s \quad dv/dt = 20 \text{ V}/\mu s \quad t_p = 200 \mu s$ | $T_{VJ} = 100^{\circ}C$ | | 185 | μs |

| Package TO-240AA | | | | Ratings | | |
|------------------|--|----------------------|-------------------------------------|---------|------|------|
| Symbol | Definition | Conditions | min. | typ. | max. | Unit |
| I_{RMS} | RMS current | per terminal | | | 200 | A |
| T_{VJ} | virtual junction temperature | | -40 | | 125 | °C |
| T_{op} | operation temperature | | -40 | | 100 | °C |
| T_{stg} | storage temperature | | -40 | | 125 | °C |
| Weight | | | | | 81 | g |
| M_D | mounting torque | | 2.5 | | 4 | Nm |
| M_T | terminal torque | | 2.5 | | 4 | Nm |
| $d_{Spp/App}$ | creepage distance on surface striking distance through air | terminal to terminal | 13.0 | 9.7 | | mm |
| $d_{Spb/Apb}$ | | terminal to backside | 16.0 | 16.0 | | mm |
| V_{ISOL} | isolation voltage | t = 1 second | | 3600 | | V |
| | | t = 1 minute | 50/60 Hz, RMS; $I_{ISOL} \leq 1$ mA | 3000 | | V |

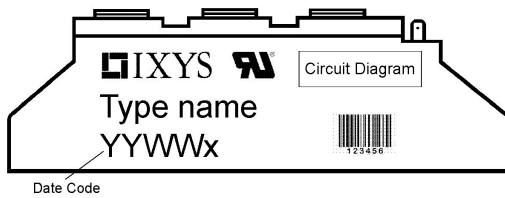

| Ordering | Ordering Number | Marking on Product | Delivery Mode | Quantity | Code No. |
|----------|-----------------|--------------------|---------------|----------|----------|
| Standard | MCD72-08io8B | MCD72-08io8B | Box | 36 | 453331 |

| Similar Part | Package | Voltage class |
|-----------------|-------------|---------------|
| MCMA85PD1200TB | TO-240AA-1B | 1200 |
| MCMA110PD1200TB | TO-240AA-1B | 1200 |

| Equivalent Circuits for Simulation | | * on die level | | $T_{VJ} = 125^\circ\text{C}$ |
|------------------------------------|--------------------|----------------|--|------------------------------|
| | Thyristor | | | |
| $V_{0\ max}$ | threshold voltage | 0.85 | | V |
| $R_{0\ max}$ | slope resistance * | 2 | | mΩ |

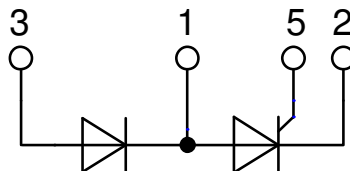
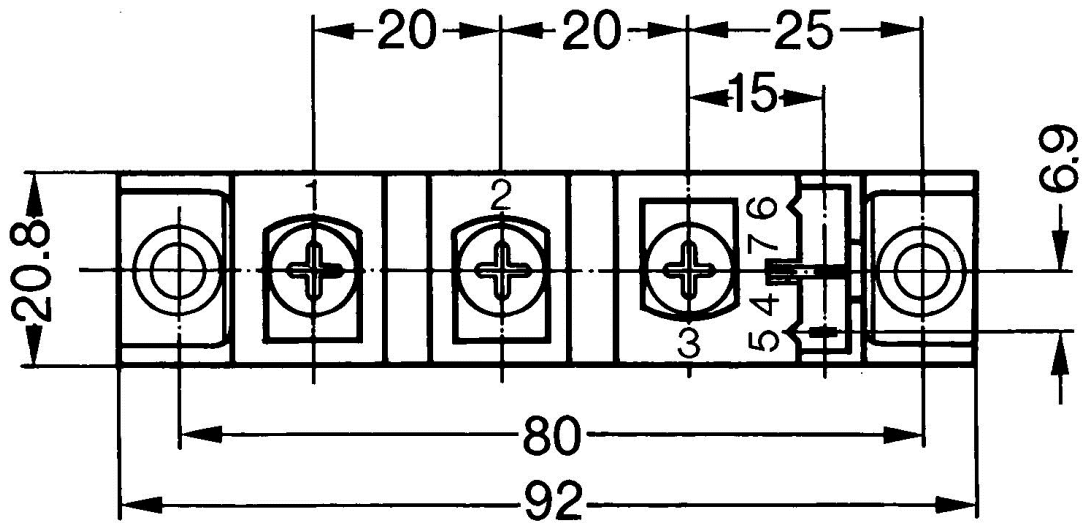
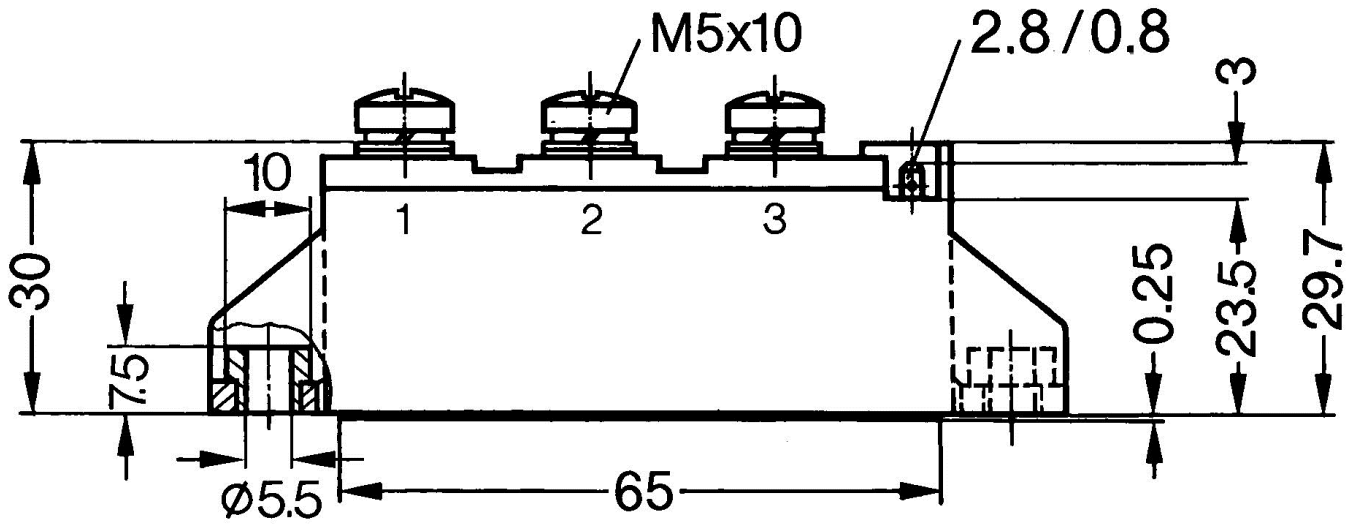

Thyristor

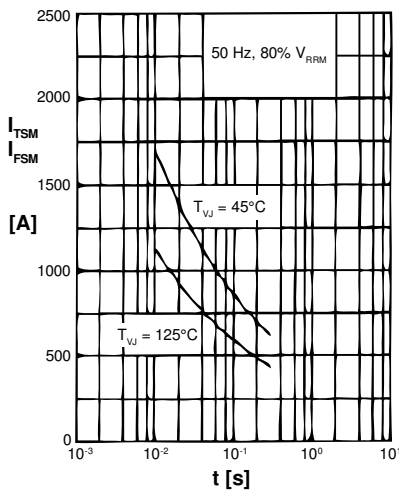

Fig. 1 Surge overload current
 I_{TSM} , I_{FSM} : Crest value, t: duration

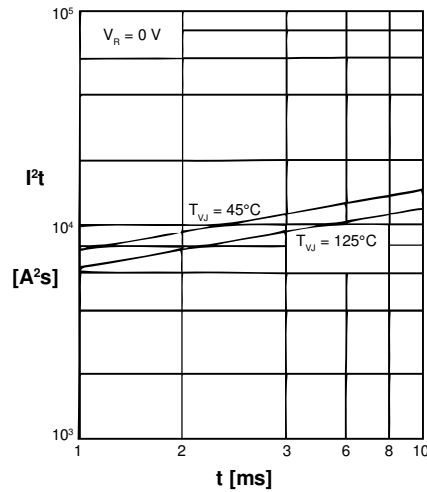

Fig. 2 I^2t versus time (1-10 ms)

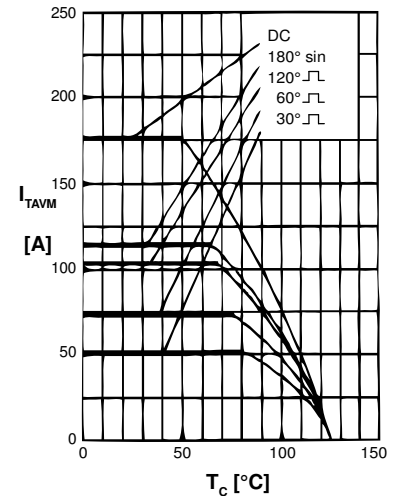

Fig. 3 Maximum forward current at case temperature

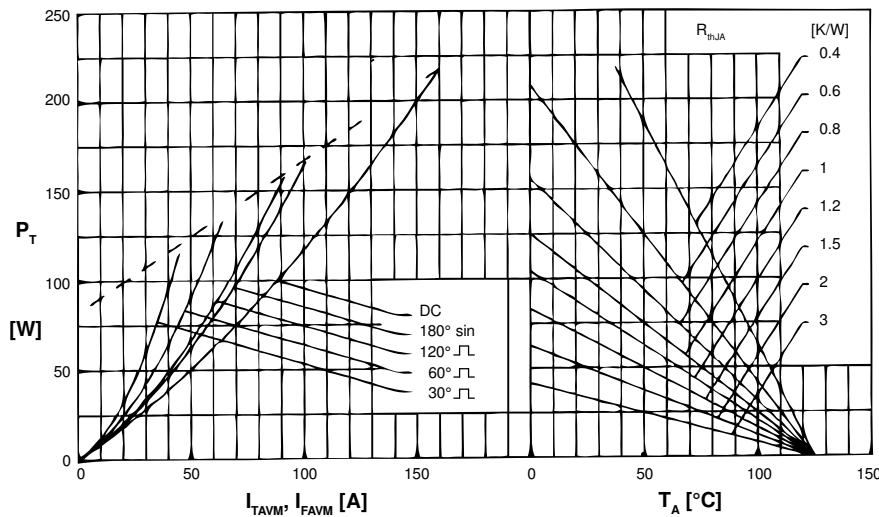

Fig. 4 Power dissipation vs. onstate current and ambient temperature (per thyristor/diode)

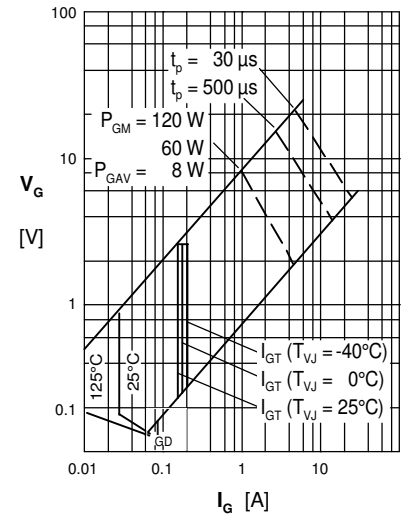

Fig. 5 Gate trigger characteristics

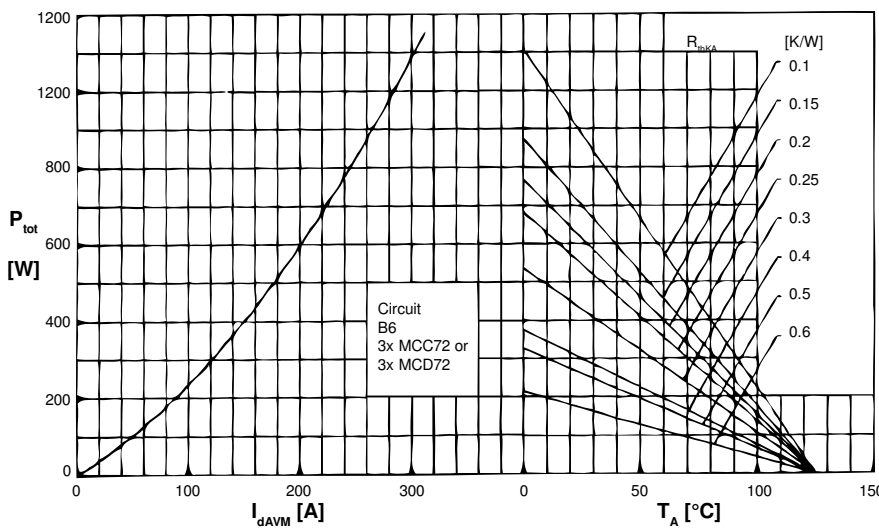

Fig. 6 Three phase rectifier bridge: Power dissipation versus direct output current and ambient temperature

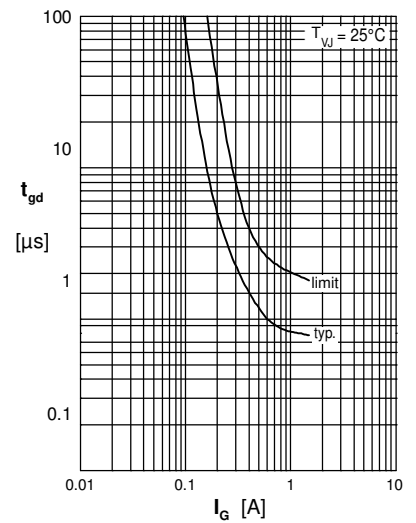

Fig. 7 Gate trigger delay time

Rectifier

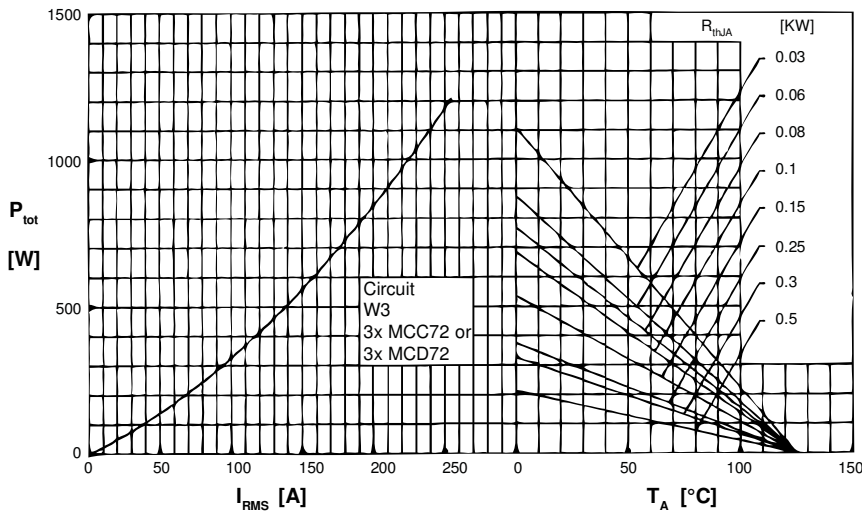

Fig. 8 Three phase AC-controller: Power dissipation versus RMS output current and ambient temperature

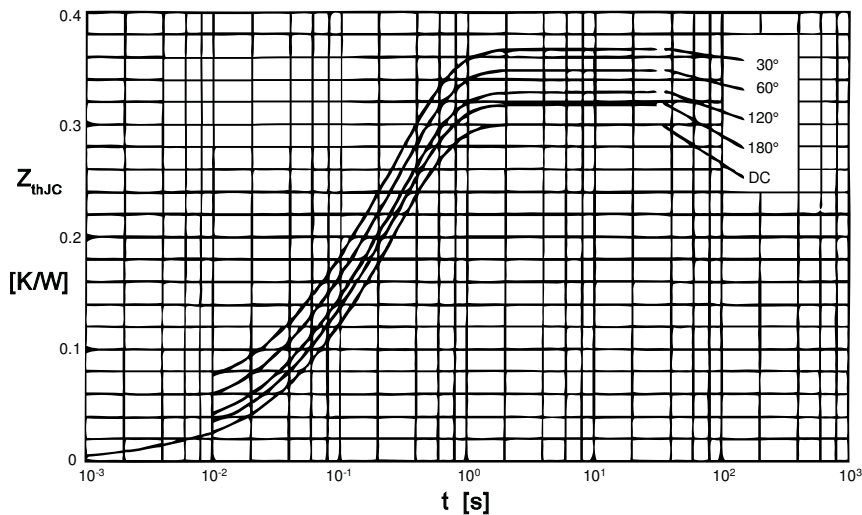

Fig. 9 Transient thermal impedance junction to case (per thyristor)

R_{thJC} for various conduction angles d :

| d | R_{thJC} [K/W] |
|------|------------------|
| DC | 0.30 |
| 180° | 0.31 |
| 120° | 0.33 |
| 60° | 0.35 |
| 30° | 0.37 |

Constants for Z_{thJC} calculation:

| i | R_{thi} [K/W] | t_i [s] |
|-----|-----------------|-----------|
| 1 | 0.008 | 0.0019 |
| 2 | 0.054 | 0.0470 |
| 3 | 0.238 | 0.3000 |

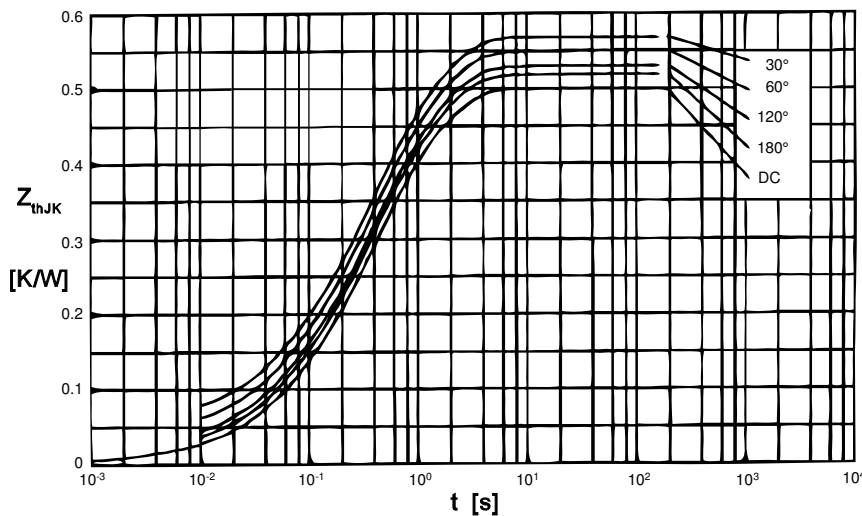

Fig. 10 Transient thermal impedance junction to heatsink (per thyristor)

R_{thJK} for various conduction angles d :

| d | R_{thJK} [K/W] |
|------|------------------|
| DC | 0.50 |
| 180° | 0.51 |
| 120° | 0.53 |
| 60° | 0.55 |
| 30° | 0.57 |

Constants for Z_{thJK} calculation:

| i | R_{thi} [K/W] | t_i [s] |
|-----|-----------------|-----------|
| 1 | 0.008 | 0.0019 |
| 2 | 0.054 | 0.0470 |
| 3 | 0.238 | 0.3000 |
| 4 | 0.200 | 1.2500 |

This datasheet has been downloaded from:

datasheet.eeworld.com.cn

Free Download

Daily Updated Database

100% Free Datasheet Search Site

100% Free IC Replacement Search Site

Convenient Electronic Dictionary

Fast Search System

www.EEworld.com.cn