

# High Voltage Thyristor Module

$$V_{RRM} = 2 \times 2200 \text{ V}$$

$$I_{TAV} = 220 \text{ A}$$

$$V_T = 1.19 \text{ V}$$

Phase leg

Part number

**MCNA220P2200YA**



Backside: isolated

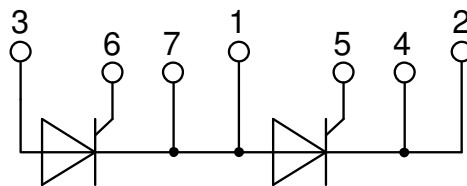
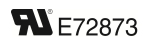

## Features / Advantages:

- Thyristor for line frequency
- Planar passivated chip
- Long-term stability

## Applications:

- Line rectifying 50/60 Hz
- Softstart AC motor control
- DC Motor control
- Power converter
- AC power control
- Lighting and temperature control

## Package: Y4

- Isolation Voltage: 4800 V~
- Industry standard outline
- RoHS compliant
- Soldering pins for PCB mounting
- Base plate: DCB ceramic
- Reduced weight
- Advanced power cycling

## Terms .Conditions of usage:

The data contained in this product data sheet is exclusively intended for technically trained staff. The user will have to evaluate the suitability of the product for the intended application and the completeness of the product data with respect to his application. The specifications of our components may not be considered as an assurance of component characteristics. The information in the valid application- and assembly notes must be considered. Should you require product information in excess of the data given in this product data sheet or which concerns the specific application of your product, please contact your local sales office.

Due to technical requirements our product may contain dangerous substances. For information on the types in question please contact your local sales office.

Should you intend to use the product in aviation, in health or life endangering or life support applications, please notify. For any such application we urgently recommend

- to perform joint risk and quality assessments;

- the conclusion of quality agreements;

- to establish joint measures of an ongoing product survey, and that we may make delivery dependent on the realization of any such measures.

Rectifier			Ratings			
Symbol	Definition	Conditions	min.	typ.	max.	Unit
$V_{RSM/DSM}$	max. non-repetitive reverse/forward blocking voltage	$T_{VJ} = 25^{\circ}C$			2300	V
$V_{RRM/DRM}$	max. repetitive reverse/forward blocking voltage	$T_{VJ} = 25^{\circ}C$			2200	V
$I_{RD}$	reverse current, drain current	$V_{R/D} = 2200\text{ V}$	$T_{VJ} = 25^{\circ}C$		400	$\mu A$
		$V_{R/D} = 2200\text{ V}$	$T_{VJ} = 125^{\circ}C$		15	mA
$V_T$	forward voltage drop	$I_T = 220\text{ A}$	$T_{VJ} = 25^{\circ}C$		1.24	V
		$I_T = 440\text{ A}$			1.51	V
		$I_T = 220\text{ A}$	$T_{VJ} = 125^{\circ}C$		1.19	V
		$I_T = 440\text{ A}$			1.53	V
$I_{TAV}$	average forward current	$T_C = 85^{\circ}C$	$T_{VJ} = 140^{\circ}C$		220	A
$I_{T(RMS)}$	RMS forward current	180° sine			345	A
$V_{T0}$	threshold voltage	} for power loss calculation only	$T_{VJ} = 140^{\circ}C$		0.84	V
$r_T$	slope resistance				1.5	m $\Omega$
$R_{thJC}$	thermal resistance junction to case				0.13	K/W
$R_{thCH}$	thermal resistance case to heatsink			0.070		K/W
$P_{tot}$	total power dissipation		$T_C = 25^{\circ}C$		885	W
$I_{TSM}$	max. forward surge current	$t = 10\text{ ms}; (50\text{ Hz}), \text{ sine}$	$T_{VJ} = 45^{\circ}C$		7.20	kA
		$t = 8,3\text{ ms}; (60\text{ Hz}), \text{ sine}$	$V_R = 0\text{ V}$		7.78	kA
		$t = 10\text{ ms}; (50\text{ Hz}), \text{ sine}$	$T_{VJ} = 140^{\circ}C$		6.12	kA
		$t = 8,3\text{ ms}; (60\text{ Hz}), \text{ sine}$	$V_R = 0\text{ V}$		6.61	kA
$I^2t$	value for fusing	$t = 10\text{ ms}; (50\text{ Hz}), \text{ sine}$	$T_{VJ} = 45^{\circ}C$		259.2	kA <sup>2</sup> s
		$t = 8,3\text{ ms}; (60\text{ Hz}), \text{ sine}$	$V_R = 0\text{ V}$		251.5	kA <sup>2</sup> s
		$t = 10\text{ ms}; (50\text{ Hz}), \text{ sine}$	$T_{VJ} = 140^{\circ}C$		187.3	kA <sup>2</sup> s
		$t = 8,3\text{ ms}; (60\text{ Hz}), \text{ sine}$	$V_R = 0\text{ V}$		181.8	kA <sup>2</sup> s
$C_J$	junction capacitance	$V_R = 700\text{ V}$ $f = 1\text{ MHz}$	$T_{VJ} = 25^{\circ}C$		195	pF
$P_{GM}$	max. gate power dissipation	$t_p = 30\text{ }\mu s$	$T_C = 140^{\circ}C$		120	W
		$t_p = 300\text{ }\mu s$			60	W
$P_{GAV}$	average gate power dissipation				8	W
$(di/dt)_{cr}$	critical rate of rise of current	$T_{VJ} = 140^{\circ}C; f = 50\text{ Hz}$ repetitive, $I_T = 660\text{ A}$			150	A/ $\mu s$
		$t_p = 200\text{ }\mu s; di_G/dt = 0.5\text{ A}/\mu s;$ $I_G = 0.5\text{ A}; V = \frac{2}{3} V_{DRM}$ non-repet., $I_T = 220\text{ A}$			500	A/ $\mu s$
$(dv/dt)_{cr}$	critical rate of rise of voltage	$V = \frac{2}{3} V_{DRM}$ $R_{GK} = \infty; \text{ method 1 (linear voltage rise)}$	$T_{VJ} = 140^{\circ}C$		1000	V/ $\mu s$
$V_{GT}$	gate trigger voltage	$V_D = 6\text{ V}$	$T_{VJ} = 25^{\circ}C$		2	V
			$T_{VJ} = -40^{\circ}C$		2.6	V
$I_{GT}$	gate trigger current	$V_D = 6\text{ V}$	$T_{VJ} = 25^{\circ}C$		150	mA
			$T_{VJ} = -40^{\circ}C$		200	mA
$V_{GD}$	gate non-trigger voltage	$V_D = \frac{2}{3} V_{DRM}$	$T_{VJ} = 140^{\circ}C$		0.2	V
$I_{GD}$	gate non-trigger current				10	mA
$I_L$	latching current	$t_p = 30\text{ }\mu s$	$T_{VJ} = 25^{\circ}C$		200	mA
		$I_G = 0.45\text{ A}; di_G/dt = 0.45\text{ A}/\mu s$				
$I_H$	holding current	$V_D = 6\text{ V}$ $R_{GK} = \infty$	$T_{VJ} = 25^{\circ}C$		200	mA
$t_{gd}$	gate controlled delay time	$V_D = \frac{1}{2} V_{DRM}$	$T_{VJ} = 25^{\circ}C$		2	$\mu s$
		$I_G = 0.5\text{ A}; di_G/dt = 0.5\text{ A}/\mu s$				
$t_q$	turn-off time	$V_R = 100\text{ V}; I_T = 220\text{ A}; V = \frac{2}{3} V_{DRM}$ $di/dt = 10\text{ A}/\mu s$ $dv/dt = 20\text{ V}/\mu s$ $t_p = 200\text{ }\mu s$	$T_{VJ} = 125^{\circ}C$		200	$\mu s$

Package Y4				Ratings			
Symbol	Definition	Conditions	min.	typ.	max.	Unit	
$I_{RMS}$	RMS current	per terminal			300	A	
$T_{VJ}$	virtual junction temperature		-40		140	°C	
$T_{op}$	operation temperature		-40		125	°C	
$T_{stg}$	storage temperature		-40		125	°C	
<b>Weight</b>					150	g	
$M_D$	mounting torque		2.25		2.75	Nm	
$M_T$	terminal torque		4.5		5.5	Nm	
$d_{Spp/APP}$	creepage distance on surface   striking distance through air	terminal to terminal	14.0	10.0		mm	
$d_{Spb/APb}$		terminal to backside	16.0	16.0		mm	
$V_{ISOL}$	isolation voltage	t = 1 second		4800		V	
		t = 1 minute	50/60 Hz, RMS; $I_{ISOL} \leq 1$ mA	4000		V	

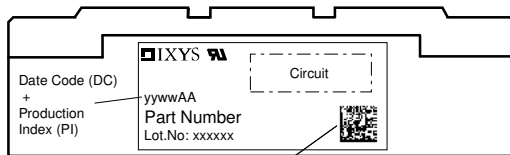

Data Matrix: part no. (1-19), DC + PI (20-25), lot.no.# (26-31), blank (32), serial no.# (33-36)

**Part description**

- M = Module
- C = Thyristor (SCR)
- N = High Voltage Thyristor
- A = ( $\geq 2000V$ )
- 220 = Current Rating [A]
- P = Phase leg
- 2200 = Reverse Voltage [V]
- YA = Y4-M6

Ordering	Ordering Number	Marking on Product	Delivery Mode	Quantity	Code No.
Standard	MCNA220P2200YA	MCNA220P2200YA	Box	6	520495

Similar Part	Package	Voltage class
MCNA150P2200YA	Y4-M6	2200
MCNA180P2200YA	Y4-M6	2200

**Equivalent Circuits for Simulation**

\* on die level

$T_{VJ} = 140^\circ C$

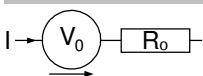

Thyristor

$V_{0\ max}$	threshold voltage	0.84	V
$R_{0\ max}$	slope resistance *	0.9	mΩ

## Outlines Y4

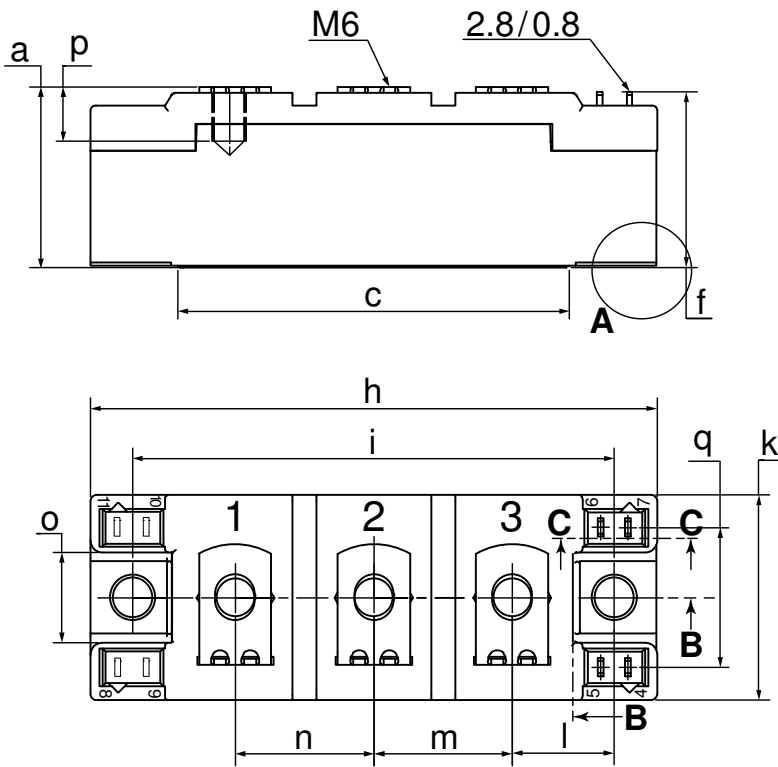

Dim.	MIN [mm]	MAX [mm]	MIN [inch]	MAX [inch]
a	30.0	30.6	1.181	1.205
b	typ. 0.25		typ. 0.010	
c	64.0	65.0	2.520	2.559
d	6.5	7.0	0.256	0.275
e	4.9	5.1	0.193	0.201
f	28.6	29.2	1.126	1.150
g	7.3	7.7	0.287	0.303
h	93.5	94.5	3.681	3.720
i	79.5	80.5	3.130	3.169
j	4.8	5.2	0.189	0.205
k	33.4	34.0	1.315	1.339
l	16.7	17.3	0.657	0.681
m	22.7	23.3	0.894	0.917
n	22.7	23.3	0.894	0.917
o	14.0	15.0	0.551	0.591
p	typ. 10.5		typ. 0.413	
q	22.8	23.3	0.898	0.917
r	1.8	2.4	0.071	0.041

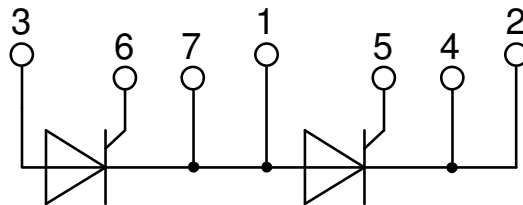
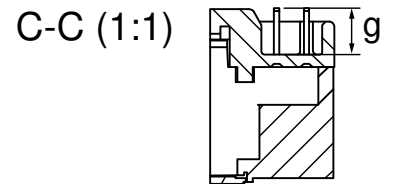
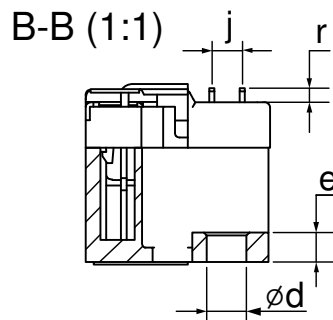
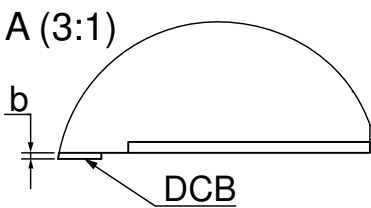

## Thyristor

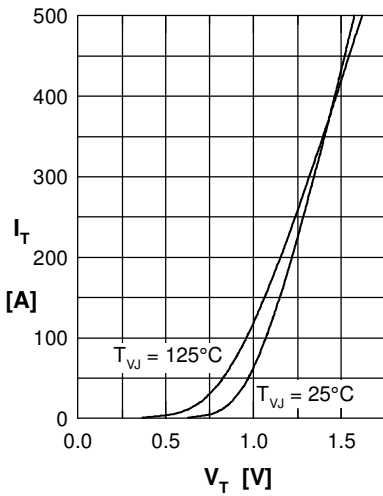

Fig. 1 Forward characteristics

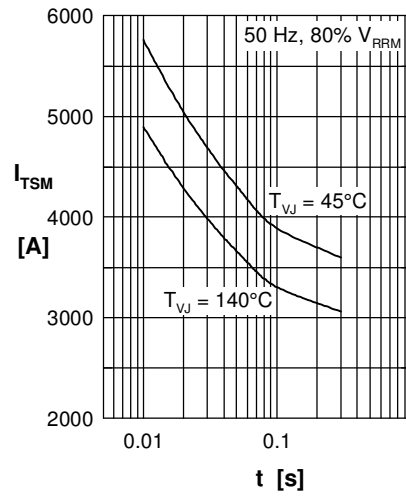

Fig. 2 Surge overload current  
 $I_{TSM}$ : crest value, t: duration

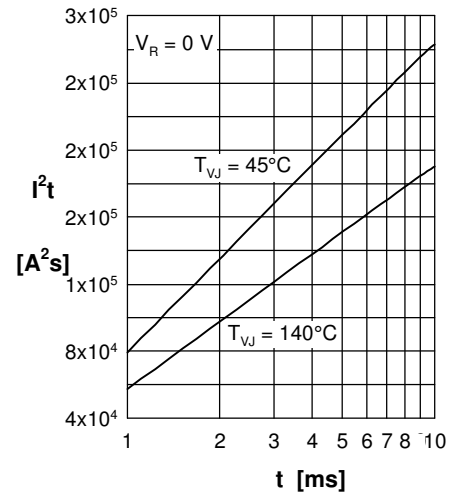

Fig. 3  $I^2t$  versus time (1-10 s)

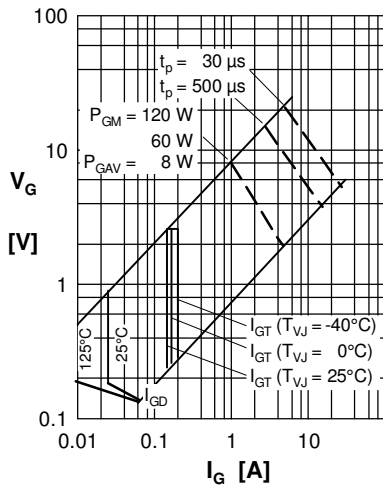

Fig. 4 Gate voltage & gate current

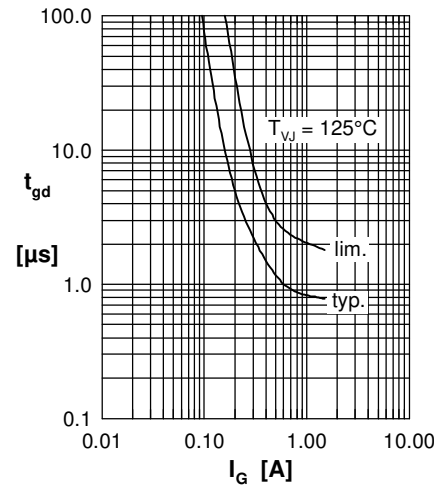

Fig. 5 Gate controlled delay time  $t_{gd}$

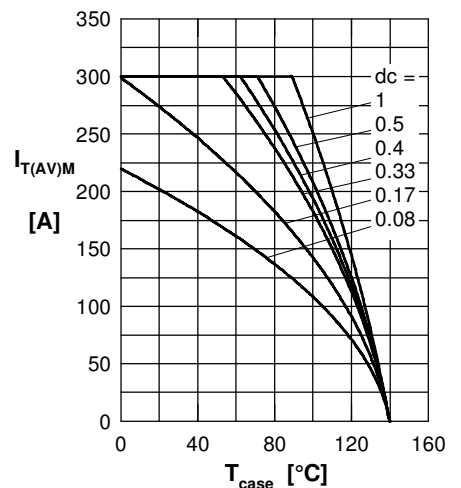

Fig. 6 Max. forward current at case temperature

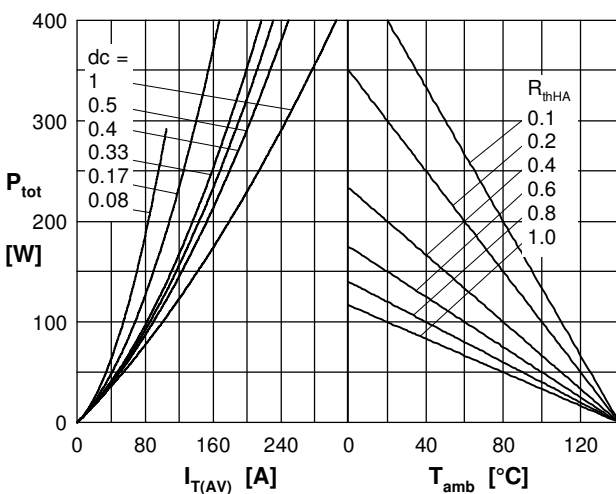

Fig. 7a Power dissipation versus direct output current  
 Fig. 7b and ambient temperature

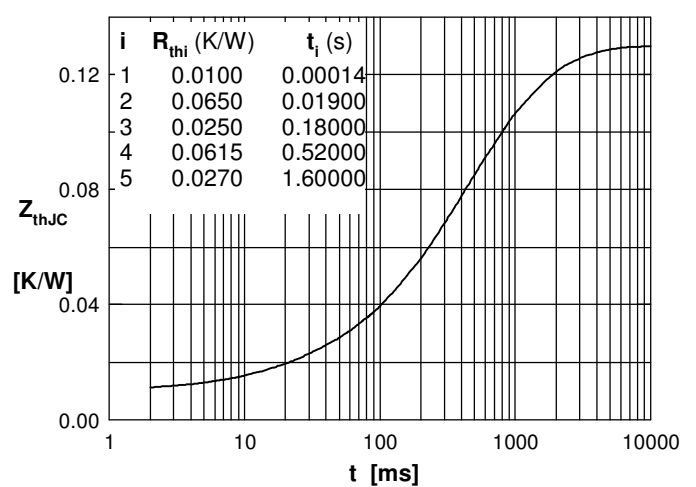

Fig. 8 Transient thermal impedance junction to case