

POWER DIODE MODULE

Features

- All the terminals and the mounting plate are electrically isolated. These modules can be installed in the same cooling fin as other modules, thus saving installation space – a cost-effective feature.
- The diode chips are coated with a glass of zinc oxide, making them highly resistant to temperature and humidity variation.
- 6 diode chips are connected to the 3-phase bridge rectifying circuit inside the module-a cost-effective feature.

Applications

- Inverters for AC motors
- Power supply units for DC motors
- DC power supply units for battery chargers
- General purpose DC power supply units

Maximum Ratings and Characteristics

Absolute Maximum Ratings

Items	Symbols	Conditions	6R130G		Units
			-120	-160	
Repetitive peak reverse voltage	V_{RRM}		1200	1600	V
Non-repetitive peak reverse voltage	V_{RSM}		1320	1760	V
Average output current	I_O	50/60 Hz Sinewave, $T_C = 88^\circ\text{C}$	30		A
Surge current	I_{FSM}	Rated load conditions	320		A
I_t^2	I_t^2	Rated load conditions	400		A^2s
Junction temperature	T_j		-40~+150		$^\circ\text{C}$
Storage temperature	T_{stg}		-40~+125		$^\circ\text{C}$
Tightening torque		Mounting screw: M5	25±5		kg·cm
Vibration resistance			5		G
Dielectric strength		Between terminals and base	2500 VAC 1 min		
Net. Weight			100		g

Electrical Characteristics

Items	Symbols	Conditions	Min	Typ	Max	Units
Forward voltage	V_{FM}	$T_j = 25^\circ\text{C}$, $I_{FM} = 30\text{ A}$			1.30	V
Reverse current	I_{RRM}	$T_j = 150^\circ\text{C}$, $V_R = V_{RRM}$			30	mA

Thermal Characteristics

Items	Symbols	Conditions	Min	Typ	Max	Units
Thermal resistance (Junction to case)	$R_{th(j-c)}$	50/60 Hz Sinewave, Thermal resistance for total loss			0.80	$^\circ\text{C}/\text{W}$
Thermal resistance	$R_{th(c-f)}$	With thermal compound			0.10	$^\circ\text{C}/\text{W}$

Outline Drawings

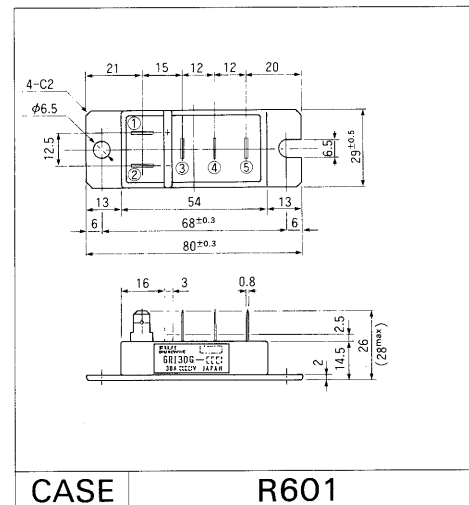

Inner Circuit Schematic

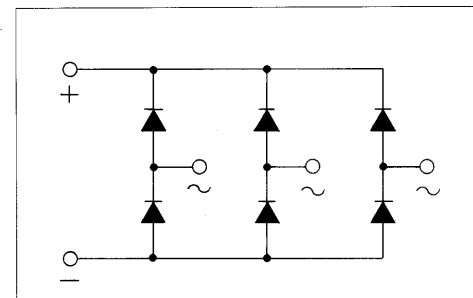

■ Characteristic curves

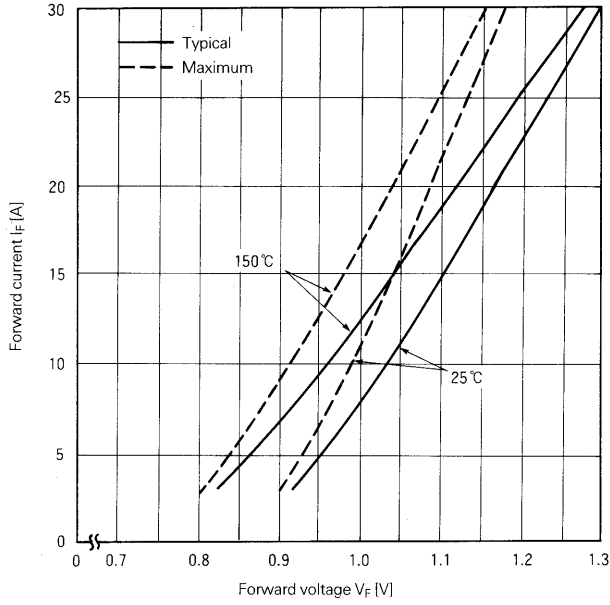

Forward Characteristics

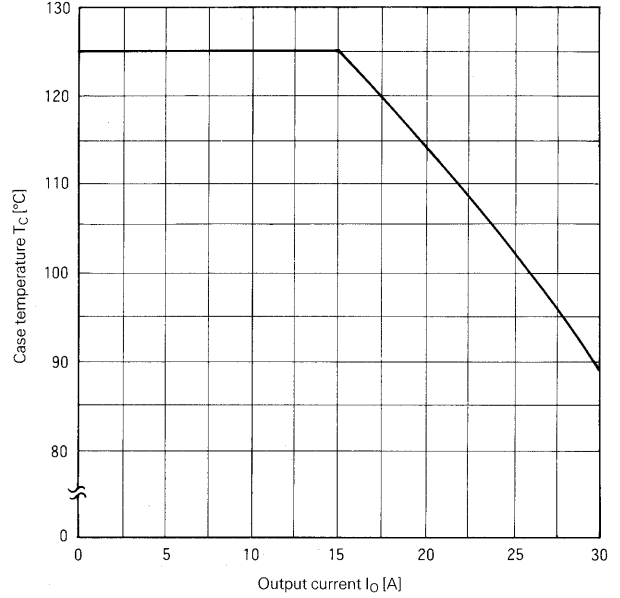

Case Temperature-Output Current

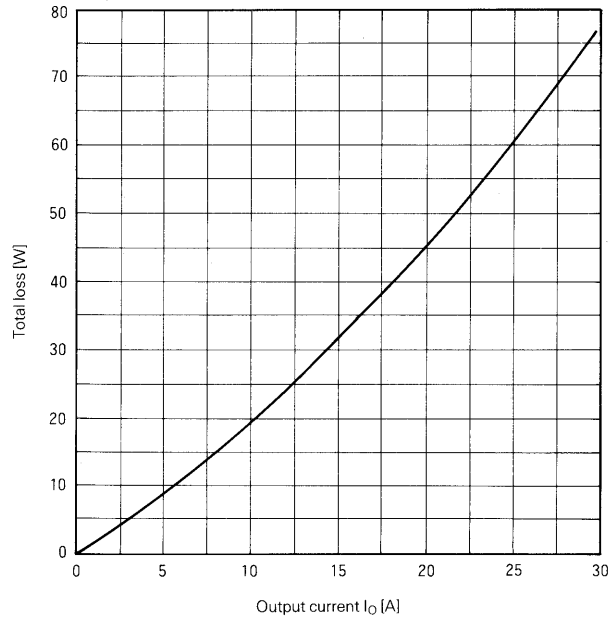

Output Current-Total Loss

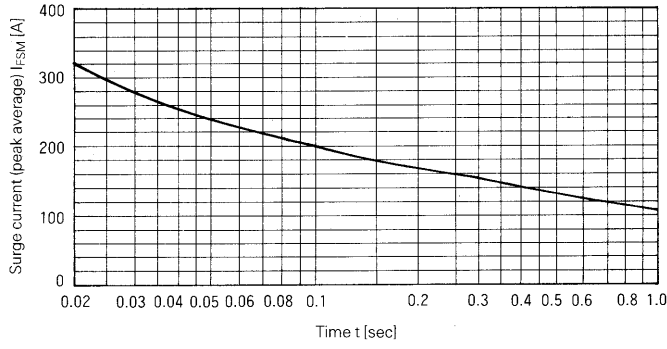

Surge Current

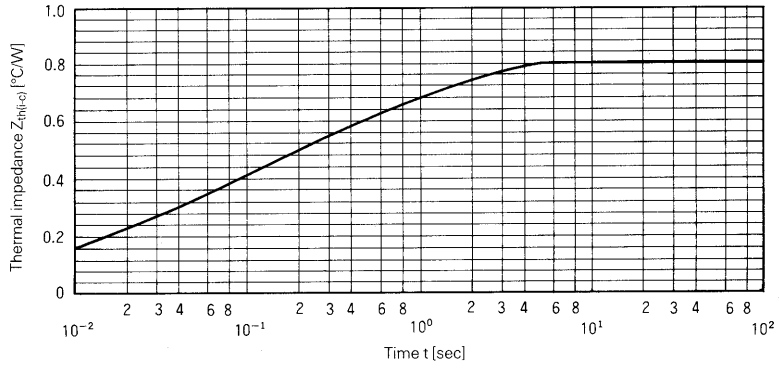

Transient Thermal Impedance

For more information, contact:

Collmer Semiconductor, Inc.

P.O. Box 702708

Dallas, TX 75370

972-733-1700

972-381-9991 Fax

<http://www.collmer.com>