

THREE PHASE DIODE+THYRISTOR

DFA50BA80/160

SanRex Power Module, **DFA50BA**, is complex isolated module which is designed for rash current circuit.

It contains six diodes connected in a three phase bridge configuration, and a thyristor connected to a direct current line.

- This Module is designed very compactly. Because diode module and thyristor put together.
- This Module is also isolated type between electorode terminal and mounting base. So you can put this Module and other one together in a same fin.

(Application)

- Inverter for AC or DC motor control, Current stabilized power supply, Switching power supply.

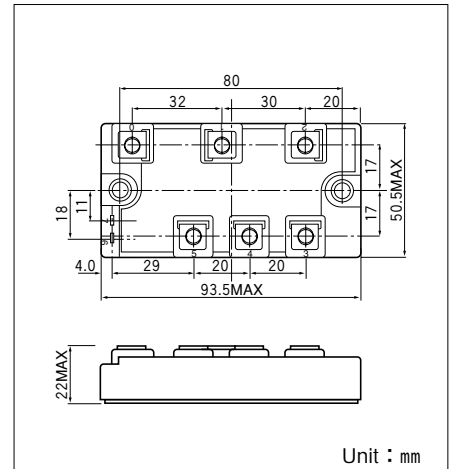
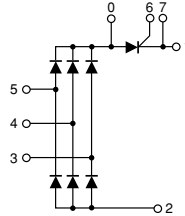

● DIODE

■ Maximum Ratings

(T_j=25°C unless otherwise specified)

Symbol	Item	Ratings		Unit
		DFA50BA80	DFA50BA160	
V _{RRM}	Repetitive Peak Reverse Voltage	800	1600	V
V _{RSM}	Non-Repetitive Peak Reverse Voltage	960	1700	V

Symbol	Item	Conditions	Ratings	Unit	
I _D	Output Current (D.C.)	Three phase full wave, T _c =117°C	50	A	
I _{FSM}	Surge forward current	1cycle, 50/60Hz, peak value, non-repetitive	730/800	A	
T _j	Operating Junction Temperature		-40 to +150	°C	
T _{stg}	Storage Temperature		-40 to +125	°C	
V _{ISO}	Isolation Breakdown Voltage (R.M.S.)	A.C. 1minute	2500	V	
	Mounting Torque	Mounting (M5)	Recommended Value 1.5-2.5 (15-25)	2.7 (28)	N·m (kgf·cm)
		Terminal (M5)	Recommended Value 1.5-2.5 (15-25)	2.7 (28)	
	Mass	Typical Value	150	g	

■ Electrical Characteristics

Symbol	Item	Conditions	Ratings	Unit
I _{RRM}	Repetitive Peak Reverse Current,max.	T _j =150°C, V _R =V _{RRM}	8	mA
V _{FM}	Forward Voltage Drop,max.	T _j =25°C, I _F =50A Inst. measurement	1.30	V
R _{th(j-c)}	Thermal Impedance, max.	Junction to Case (TOTAL)	0.25	°C/W
R _{th(c-f)}	Thermal Impedance, max.	Case to Fin	0.10	°C/W

● THYRISTOR

■ Maximum Ratings

(T_j=25°C unless otherwise specified)

Symbol	Item	Ratings		Unit
		DFA50BA80	DFA50BA160	
V _{RRM}	Repetitive Peak Reverse Voltage	800	1600	V
V _{RSM}	Non-Repetitive Peak Reverse Voltage	960	1700	V
V _{DRM}	Repetitive Peak off-State Voltage	800	1600	V

Symbol	Item	Conditions	Ratings	Unit	
I _{T(AV)}	Average On-State Current	Singl phase half wave. 180° conduction, T _c =85°C	50	A	
I _{TSM}	Surge On-State Current	1 cycle, 50/60Hz, peak value, non-repetitive	730/800	A	
I ² t	I ² t		2660	A ² S	
di/dt	Critical Rate of Rise of On-State Current	I _G =100mA, V _D =½V _{DRM} , di _G /dt=0.1A/μs	150	A/μs	
V _{iso}	Isolation Breakdown Voltage (R.M.S.)	A.C. 1minute	2500	V	
T _j	Operating Junction Temperature		-40 to +135	°C	
T _{stg}	Storage Temperature		-40 to +125	°C	
	Mounting Torque	Mounting (M5)	Recommended Value 1.5-2.5 (15-25)	2.7 (28)	N·m (kgf·cm)
		Terminal (M5)	Recommended Value 1.5-2.5 (15-25)	2.7 (28)	
	Mass	Typical Value		150	g

■ Electrical Characteristics

Symbol	Item	Conditions	Ratings	Unit
I _{DRM}	Repetitive Peak Off-State Current,max.	T _j =135°C, V _D =V _{DRM}	50	mA
I _{RRM}	Repetitive Peak Reverse Current,max.	T _j =135°C, V _D =V _{RRM}	50	mA
V _{TM}	Peak On-State Voltage,max.	T _j =25°C, I _{TM} =50A, Inst. measurement	1.25	V
I _{GT}	Gate Trigger Current,max.	V _D =6V, I _T =1A	70	mA
V _{GT}	Gate Trigger Voltage,max.	V _D =6V, I _T =1A	3	V
dv/dt	Critical Rate of Rise of Off-State Voltage,min.	T _j =125°C, V _D =⅔V _{DRM}	500	V/μs
R _{th(j-c)}	Thermal Impedance, max.	Junction to Case	0.80	°C/W
R _{th(c-f)}	Thermal Impedance, max.	Case to Fin	0.10	°C/W

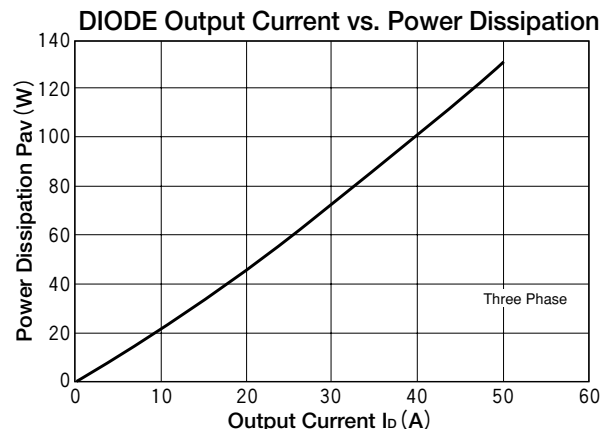
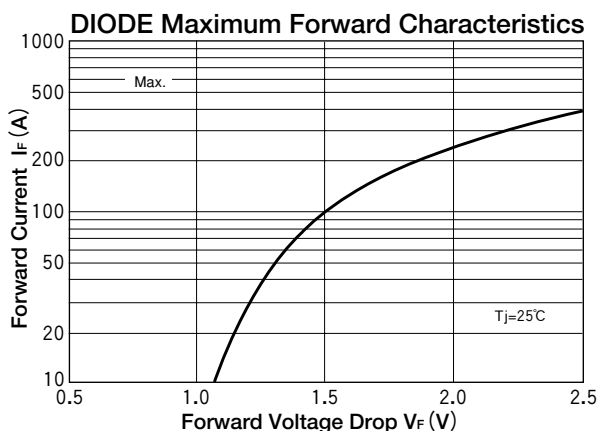

DIODE Output Current vs. Allowable case Temperature

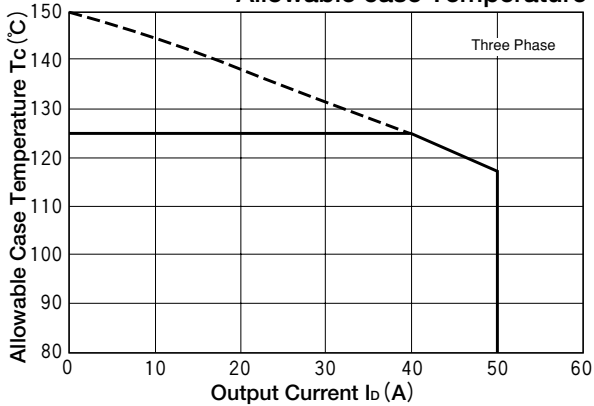

Surge Forward Current Rating (Non-Repetitive)

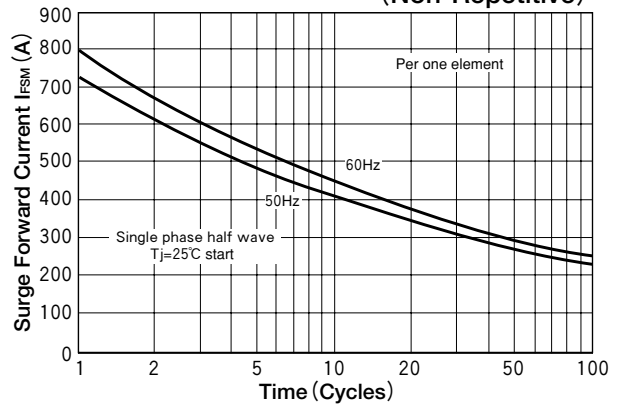

DIODE Transient Thermal Impedance

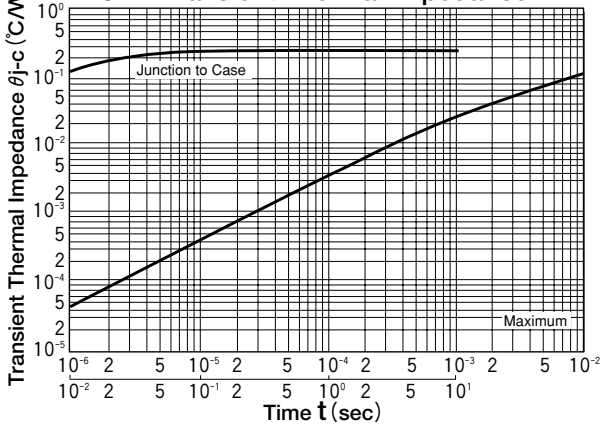

Gate Characteristics

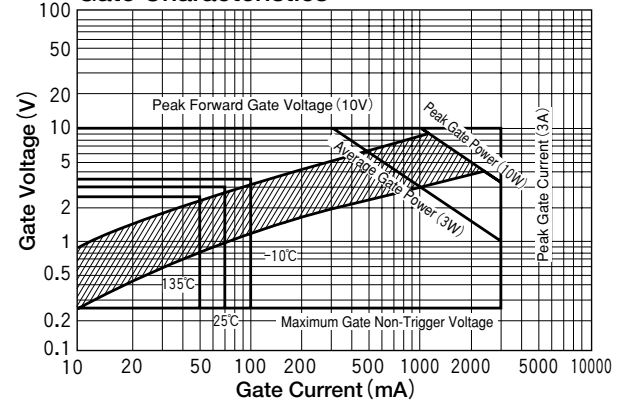

SCR Maximum Forward Characteristics

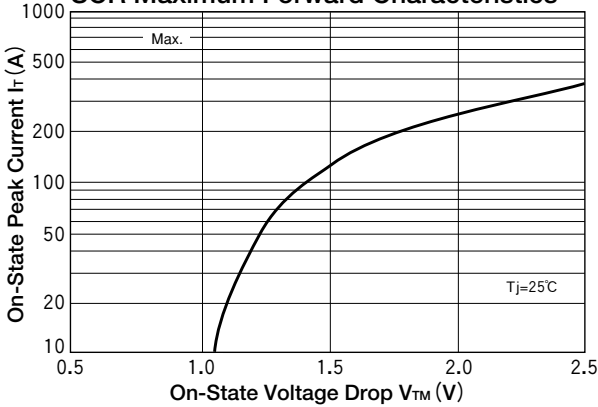

SCR Output Current vs. Power Dissipation

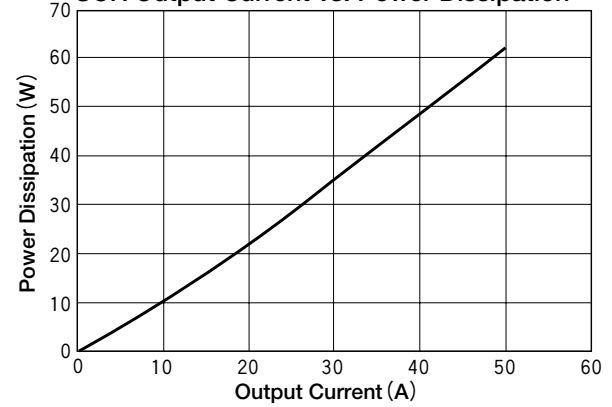

SCR Output Current vs. Maximum Allowable case Temperature

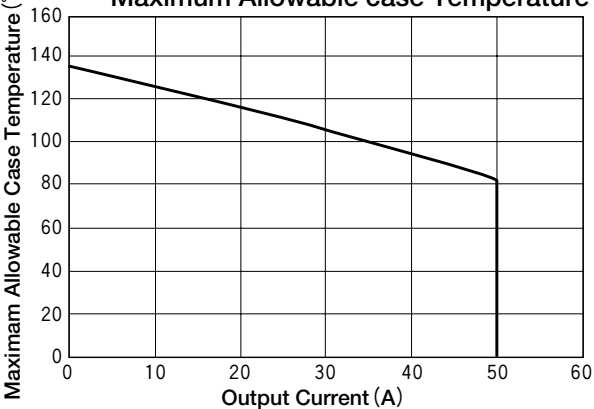

SCR Transient Thermal Impedance

