

FFA40UP35S

Features

- High Speed Switching, $t_{rr} < 55\text{ns}$ @ $I_F = 40\text{A}$
- High Reverse Voltage and High Reliability
- Avalanche Energy Rated
- Low Forward Voltage, $V_F < 1.6\text{V}$
- RoHS compliant

Applications

- General Purpose
- Switching Mode Power Supply
- Free-wheeling diode for motor application
- Power switching circuits



40A, 350V Ultrafast Rectifier

The FFA40UP35S is ultrafast rectifier with low forward voltage drop. It is silicon nitride passivated ion-implanted epitaxial planar construction.

This device is intended for use as freewheeling/clamping rectifiers in a variety of switching power supplies and other power switching applications. Its low stored charge and hyperfast soft recovery minimize ringing and electrical noise in many power switching circuits reducing power loss in the switching transistors.

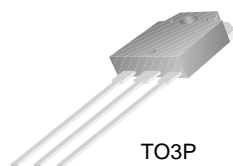

TO3P

1. Anode 2. Cathode 3. Anode

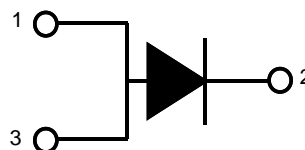

1. Anode 2. Cathode 3. Anode

Absolute Maximum Ratings $T_C = 25^\circ\text{C}$ unless otherwise noted

Symbol	Parameter	Ratings	Units
V_{RRM}	Peak Repetitive Reverse Voltage	350	V
V_{RWM}	Working Peak Reverse Voltage	350	V
V_R	DC Blocking Voltage	350	V
$I_{F(AV)}$	Average Rectified Forward Current @ $T_C = 111^\circ\text{C}$	40	A
I_{FSM}	Non-repetitive Peak Surge Current 60Hz Single Half-Sine Wave	400	A
T_J, T_{STG}	Operating and Storage Temperature Range	-65 to +150	$^\circ\text{C}$

Thermal Characteristics

Symbol	Parameter	Ratings	Units
$R_{\theta JC}$	Maximum Thermal Resistance, Junction to Case	0.8	$^\circ\text{C/W}$

Package Marking and Ordering Information

Device Marking	Device	Package	Reel Size	Tape Width	Quantity
F40UP35S	FFA40UP35STU	TO3P	-	-	30

Electrical Characteristics $T_C = 25^\circ\text{C}$ unless otherwise noted

Symbol	Parameter	Min.	Typ.	Max.	Units
V_{FM1}	$I_F = 40\text{A}$ $I_F = 40\text{A}$	-	-	1.6 1.5	V
I_{RM1}	$V_R = 350\text{V}$ $V_R = 350\text{V}$	-	-	100 500	μA
t_{rr}	$I_F = 1\text{A}, di/dt = 100\text{A}/\mu\text{s}, V_R = 30\text{V}$ $I_F = 40\text{A}, di/dt = 200\text{A}/\mu\text{s}, V_R = 230\text{V}$	-	26 28	53 55	ns
t_a	$I_F = 40\text{A}, di/dt = 200\text{A}/\mu\text{s}, V_R = 230\text{V}$	-	17	-	ns
t_b		-	11	-	ns
Q_{rr}		-	36	-	nC
W_{AVL}	Avalanche Energy ($L = 40\text{mH}$)	20	-	-	mJ

Notes:

1: Pulse: Test Pulse width = 300 μs , Duty Cycle = 2%

Test Circuit and Waveforms

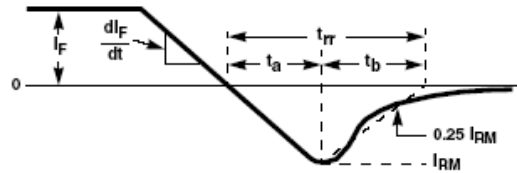
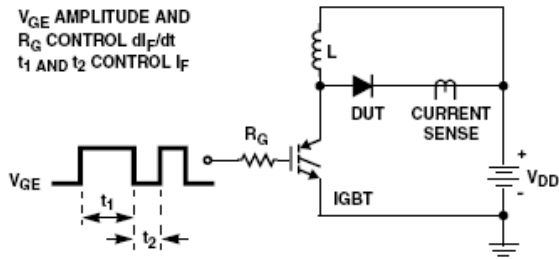

$L = 40\text{mH}$
 $R < 0.1\Omega$
 $V_{DD} = 50\text{V}$
 $E_{AVL} = 1/2LI^2 [V_{R(AVL)}/(V_{R(AVL)} - V_{DD})]$
 $Q1 = \text{IGBT } (BV_{CES} > \text{DUT } V_{R(AVL)})$

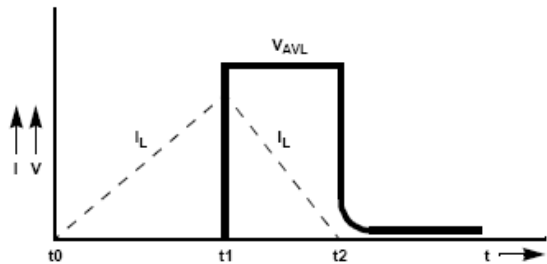
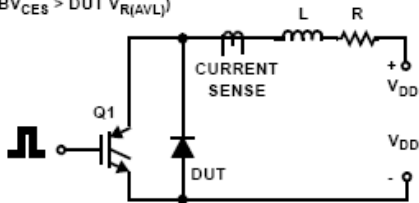

Typical Performance Characteristics

Figure 1. Typical Forward Voltage Drop vs. Forward Current

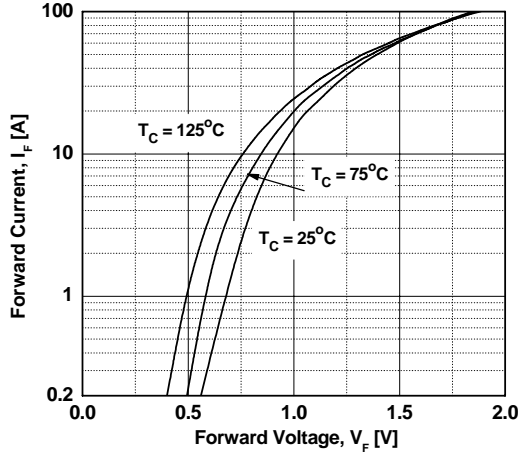

Figure 3. Typical Junction Capacitance

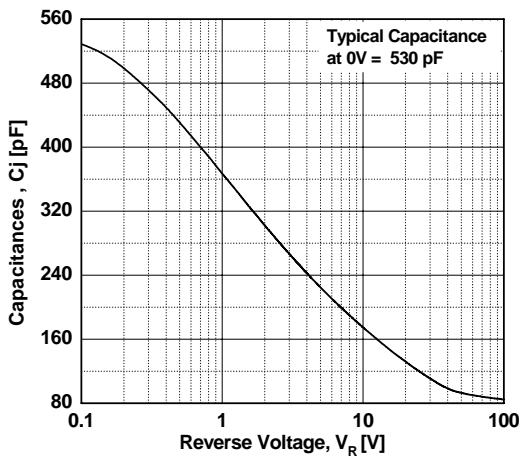

Figure 5. Typical Reverse Recovery Current vs. di/dt

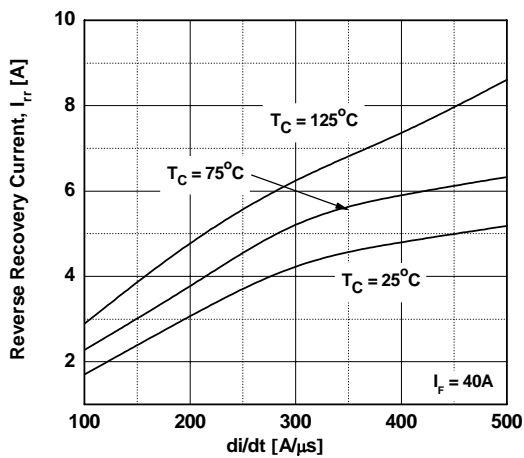

Figure 2. Typical Reverse Current vs. Reverse Voltage

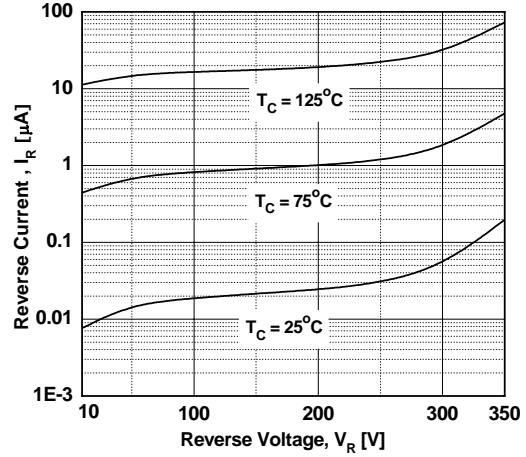

Figure 4. Typical Reverse Recovery Time vs. di/dt

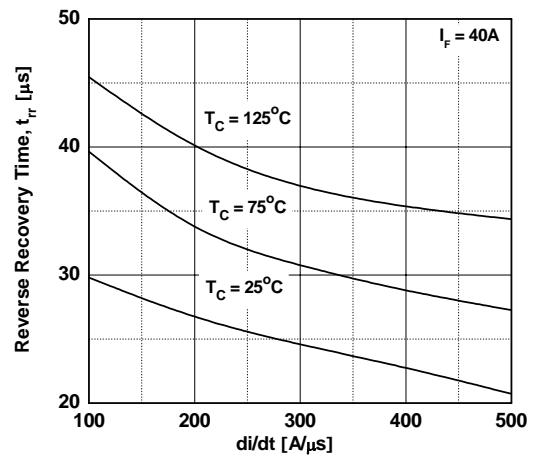
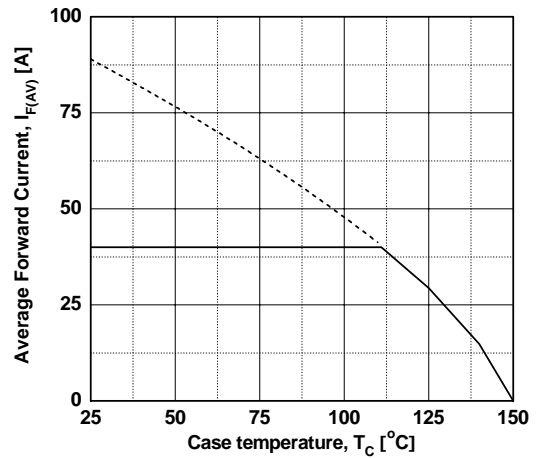
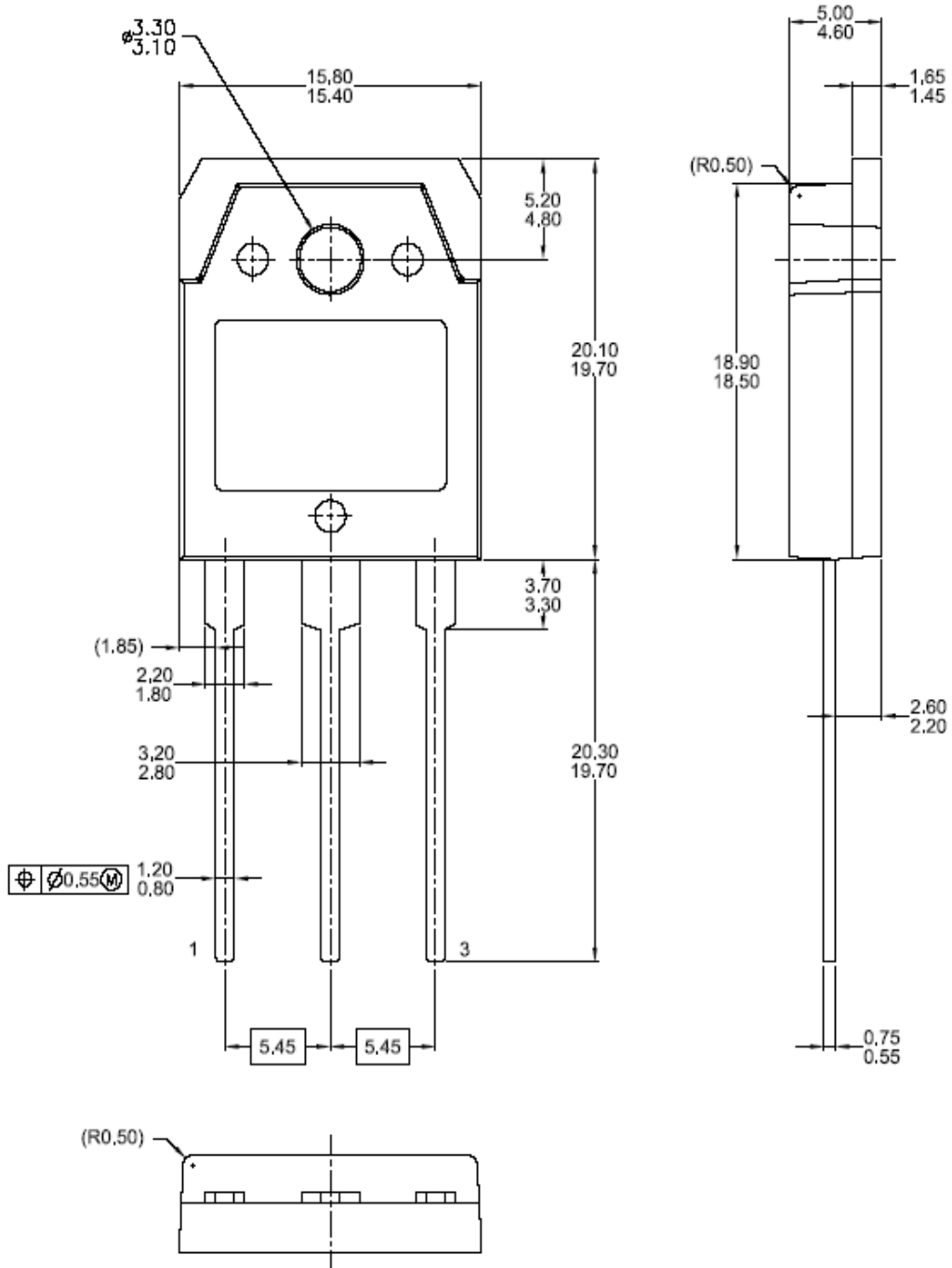

Figure 6. Forward Current Derating Curve



Mechanical Dimensions

TO3P







Dimensions in Millimeters



TRADEMARKS

The following are registered and unregistered trademarks and service marks Fairchild Semiconductor owns or is authorized to use and is not intended to be an exhaustive list of all such trademarks.

- | | | | |
|---|---|----------------------------|--|
| ACEx® | FPS™ | PDP-SPM™ | SyncFET™ |
| Build it Now™ | FRFET® | Power220® |  The Power Franchise® |
| CorePLUS™ | Global Power Resource SM | Power247® |  franchise |
| CROSSVOLT™ | Green FPS™ | POWEREDGE® | TinyBoost™ |
| CTL™ | Green FPS™ e-Series™ | Power-SPM™ | TinyBuck™ |
| Current Transfer Logic™ | GTO™ | PowerTrench® | TinyLogic® |
| EcoSPARK® | i-Lo™ | Programmable Active Droop™ | TINYOPTO™ |
| EZSWITCH™ * | IntelliMAX™ | QFET® | TinyPower™ |
|  | ISOPLANAR™ | QS™ | TinyPWM™ |
|  | MegaBuck™ | QT Optoelectronics™ | TinyWire™ |
| Fairchild® | MICROCOUPLER™ | Quiet Series™ | μSerDes™ |
| Fairchild Semiconductor® | MicroFET™ | RapidConfigure™ | UHC® |
| FACT Quiet Series™ | MicroPak™ | SMART START™ | Ultra FRFET™ |
| FACT® | MillerDrive™ | SPM® | UniFET™ |
| FAST® | Motion-SPM™ | STEALTH™ | VCX™ |
| FastvCore™ | OPTOLOGIC® | SuperFET™ | |
| FlashWriter® * | OPTOPLANAR® | SuperSOT™-3 | |
| |  | SuperSOT™-6 | |
| | | SuperSOT™-8 | |

* EZSWITCH™ and FlashWriter® are trademarks of System General Corporation, used under license by Fairchild Semiconductor.

DISCLAIMER

FAIRCHILD SEMICONDUCTOR RESERVES THE RIGHT TO MAKE CHANGES WITHOUT NOTICE TO ANY PRODUCTS HEREIN TO IMPROVE RELIABILITY, FUNCTION, OR DESIGN. FAIRCHILD DOES NOT ASSUME ANY LIABILITY ARISING OUT OF THE APPLICATION OR USE OF ANY PRODUCT OR CIRCUIT DESCRIBED HEREIN; NEITHER DOES IT CONVEY ANY LICENSE UNDER ITS PATENT RIGHTS, NOR THE RIGHTS OF OTHERS. THESE SPECIFICATIONS DO NOT EXPAND THE TERMS OF FAIRCHILD'S WORLDWIDE TERMS AND CONDITIONS, SPECIFICALLY THE WARRANTY THEREIN, WHICH COVERS THESE PRODUCTS.

LIFE SUPPORT POLICY

FAIRCHILD'S PRODUCTS ARE NOT AUTHORIZED FOR USE AS CRITICAL COMPONENTS IN LIFE SUPPORT DEVICES OR SYSTEMS WITHOUT THE EXPRESS WRITTEN APPROVAL OF FAIRCHILD SEMICONDUCTOR CORPORATION.

As used herein:

- Life support devices or systems are devices or systems which, (a) are intended for surgical implant into the body, or (b) support or sustain life, and (c) whose failure to perform when properly used in accordance with instructions for use provided in the labeling, can be reasonably expected to result in significant injury to the user.
- A critical component is any component of a life support device or system whose failure to perform can be reasonably expected to cause the failure of the life support device or system, or to affect its safety or effectiveness.

PRODUCT STATUS DEFINITIONS

Definition of Terms

Datasheet Identification	Product Status	Definition
Advance Information	Formative or In Design	This datasheet contains the design specifications for product development. Specifications may change in any manner without notice.
Preliminary	First Production	This datasheet contains preliminary data; supplementary data will be published at a later date. Fairchild Semiconductor reserves the right to make changes at any time without notice to improve design.
No Identification Needed	Full Production	This datasheet contains final specifications. Fairchild Semiconductor reserves the right to make changes at any time without notice to improve design.
Obsolete	Not In Production	This datasheet contains specifications on a product that has been discontinued by Fairchild semiconductor. The datasheet is printed for reference information only.

Rev. I32

This datasheet has been downloaded from:

www.EEworld.com.cn

Free Download

Daily Updated Database

100% Free Datasheet Search Site

100% Free IC Replacement Search Site

Convenient Electronic Dictionary

Fast Search System

www.EEworld.com.cn