

SKiM[®] 4

IGBT Modules

SKiM401MLI07E4

Features

- IGBT 4 Trench Gate Technology
- Solder technology
- $V_{CE(sat)}$ with positive temperature coefficient
- Low inductance case
- Isolated by Al₂O₃ DCB (Direct Copper Bonded) ceramic substrate
- Pressure contact technology for thermal contacts
- Spring contact system to attach driver PCB to the control terminals
- High short circuit capability, self limiting to 6 x I_C
- Integrated temperature sensor

Typical Applications*

- UPS
- 3 Level Inverter

Remarks

- Case temperature limited to T_C = 125°C max, recommended T_{op} = -40 ... +150°C

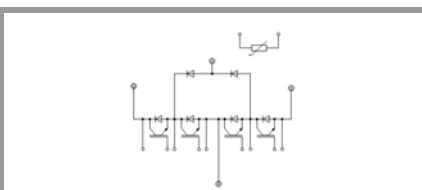

MLI

Absolute Maximum Ratings

Symbol	Conditions	Values	Unit	
IGBT				
V _{CEs}		650	V	
I _C	T _J = 175 °C	T _s = 25 °C T _s = 70 °C	317 250	A A
I _{Cnom}		400	A	
I _{CRM}	I _{CRM} = 2xI _{Cnom}	800	A	
V _{GES}		-20 ... 20	V	
t _{psc}	V _{CC} = 360 V V _{GE} ≤ 15 V V _{CEs} ≤ 650 V	T _J = 150 °C	6	μs
T _J		-40 ... 175	°C	
Inverse diode				
I _F	T _J = 175 °C	T _s = 25 °C T _s = 70 °C	266 205	A A
I _{Fnom}		400	A	
I _{FRM}	I _{FRM} = 2xI _{Fnom}	800	A	
I _{FSM}	t _p = 10 ms, sin 180°, T _J = 25 °C	2160	A	
T _J		-40 ... 175	°C	
Clamping diode				
I _F	T _J = 175 °C	T _s = 25 °C T _s = 70 °C	266 205	A A
I _{Fnom}		300	A	
I _{FRM}	I _{FRM} = 2xI _{Fnom}	600	A	
I _{FSM}	t _p = 10 ms, sin 180°, T _J = 25 °C	2160	A	
T _J		-40 ... 175	°C	
Module				
I _{t(RMS)}	T _{terminal} = 80 °C	400	A	
T _{stg}		-40 ... 125	°C	
V _{isol}	AC sinus 50 Hz, t = 1 min	2500	V	

Characteristics

Symbol	Conditions	min.	typ.	max.	Unit	
IGBT						
V _{CE(sat)}	I _C = 400 A V _{GE} = 15 V chipelevel		T _J = 25 °C T _J = 150 °C	1.45 1.85	V V	
V _{CE0}			T _J = 25 °C T _J = 150 °C	0.9 0.85	1 0.9	V V
r _{CE}	V _{GE} = 15 V		T _J = 25 °C T _J = 150 °C	1.4 2.1	2.1 3.0	mΩ mΩ
V _{GE(th)}	V _{GE} = V _{CE} , I _C = 6.4 mA	5	5.8	6.5	V	
I _{CEs}	V _{GE} = 0 V V _{CE} = 650 V		T _J = 25 °C T _J = 150 °C		mA mA	
C _{ies}	V _{CE} = 25 V V _{GE} = 0 V		f = 1 MHz	24.67	nF	
C _{oes}			f = 1 MHz	1.54	nF	
C _{res}			f = 1 MHz	0.73	nF	
Q _G	V _{GE} = -8 V...+ 15 V			3200	nC	
R _{Gint}	T _J = 25 °C			1.0	Ω	

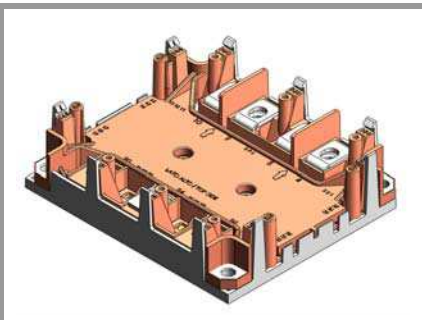

SKiM[®] 4

IGBT Modules

SKiM401MLI07E4

Features

- IGBT 4 Trench Gate Technology
- Solder technology
- $V_{CE(sat)}$ with positive temperature coefficient
- Low inductance case
- Isolated by Al₂O₃ DCB (Direct Copper Bonded) ceramic substrate
- Pressure contact technology for thermal contacts
- Spring contact system to attach driver PCB to the control terminals
- High short circuit capability, self limiting to 6 x I_C
- Integrated temperature sensor

Typical Applications*

- UPS
- 3 Level Inverter

Remarks

- Case temperature limited to T_C = 125°C max, recommended T_{op} = -40 ... +150°C

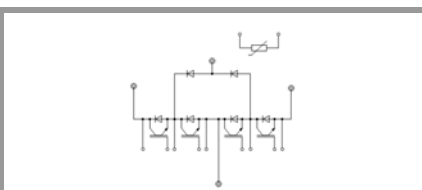

MLI

Characteristics						
Symbol	Conditions		min.	typ.	max.	Unit
t _{d(on)}	V _{CE} = 300 V I _C = 400 A	T _J = 150 °C		149.14		ns
t _r		T _J = 150 °C		79.7		ns
E _{on}	R _{G on} = 2 Ω	T _J = 150 °C		3.32		mJ
t _{d(off)}	R _{G off} = 2 Ω	T _J = 150 °C		420		ns
t _f	di/dt _{on} = 1112 A/μs di/dt _{off} = 3801 A/μs	T _J = 150 °C		180		ns
E _{off}		T _J = 150 °C		20.91		mJ
R _{th(j-s)}				0.25		K/W

Characteristics						
Symbol	Conditions		min.	typ.	max.	Unit
Inverse diode						
V _F = V _{EC}	I _F = 400 A V _{GE} = 0 V chipelevel	T _J = 25 °C		1.5	1.9	V
		T _J = 150 °C		1.6	2.0	V
V _{F0}		T _J = 25 °C	0.95	1.04	1.236	V
		T _J = 150 °C		0.85	0.99	V
r _F		T _J = 25 °C	0.8	1.2	1.8	mΩ
		T _J = 150 °C		1.8	2.6	mΩ
I _{RRM}						A
Q _{rr}				24		μC
E _{rr}	V _{GE} = -15 V V _R = 300 V					mJ
R _{th(j-s)}	per diode			0.35		K/W
Clamping diode						
V _F = V _{EC}	I _F = 300 A V _{GE} = 0 V chipelevel	T _J = 25 °C		1.4	1.8	V
		T _J = 150 °C		1.4	1.8	V
V _{F0}		T _J = 25 °C	0.95	1.04	1.236	V
		T _J = 150 °C		0.85	0.99	V
r _F		T _J = 25 °C	0.8	1.2	1.8	mΩ
		T _J = 150 °C		1.8	2.6	mΩ
I _{RRM}				127		A
Q _{rr}						μC
E _{rr}	V _{GE} = -15 V V _R = 300 V			1.8		mJ
R _{th(j-s)}	per diode			0.35		K/W
Module						
L _{CE}				22		nH
R _{CC+EE'}	terminal-chip	T _s = 25 °C		1.35		mΩ
		T _s = 125 °C		1.75		mΩ
M _s	to heat sink (M5)		2		3	Nm
M _t	to terminals M6		4		5	Nm
w				317		g
Temperature Sensor						
R ₁₀₀	T _c = 100°C (R ₂₅ = 5 kΩ)			493 ± 5%		Ω
B _{100/125}	R _(T) = R ₁₀₀ exp[B _{100/125} (1/T - 1/T ₁₀₀)]; T[K];			3550 ± 2%		K

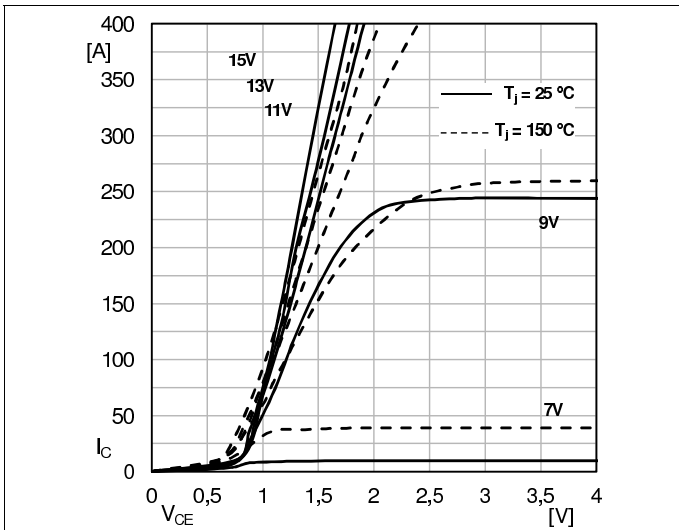

Fig. 3: Typ. IGBT output characteristic, inclusive R_{CC+EE}

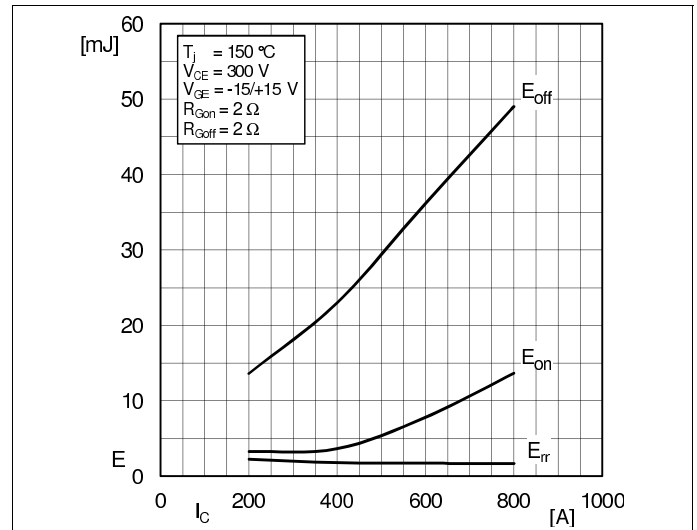

Fig. 6: Typ. turn-on /-off energy = $f(I_c)$

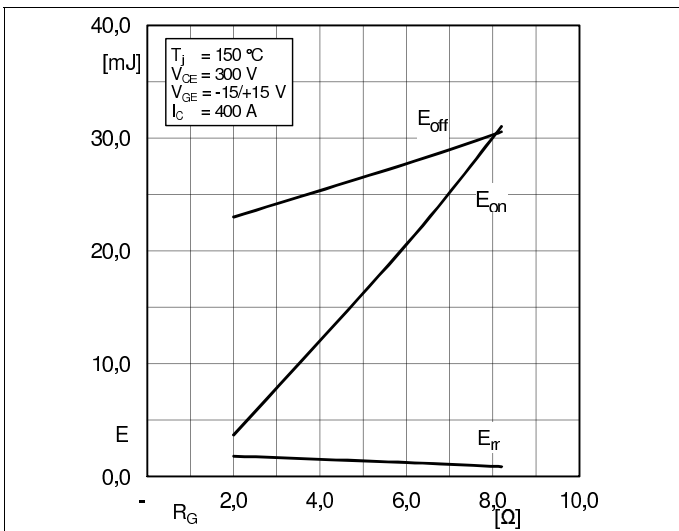

Fig. 8: Typ. turn-on /-off energy = $f(R_G)$

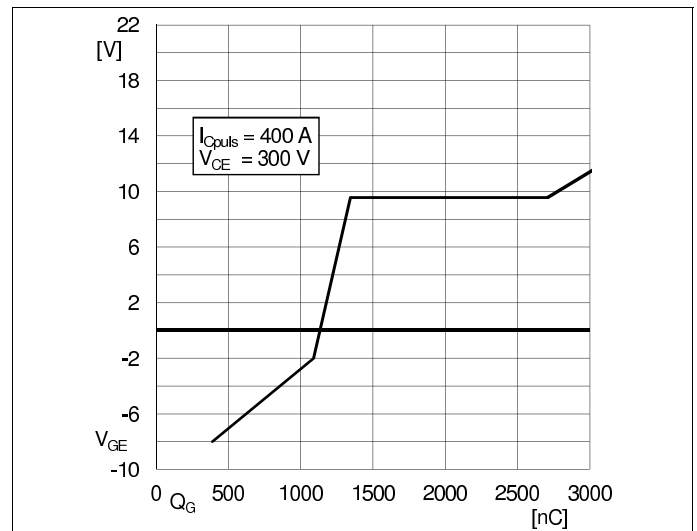

Fig. 10: Gate charge characteristic

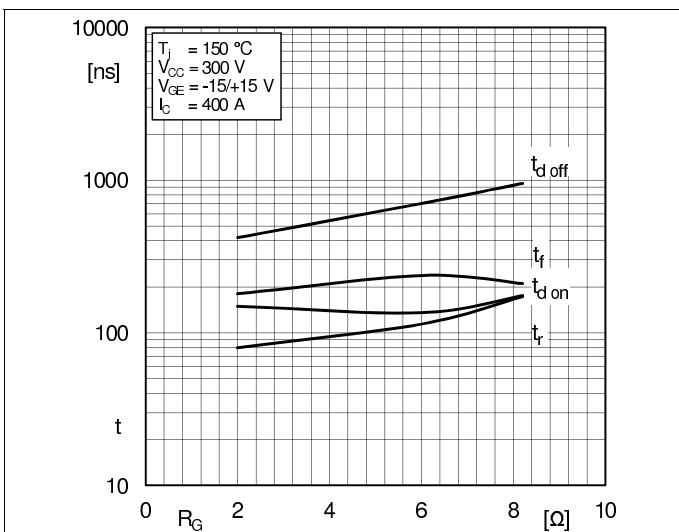

Fig. 12: Typ. switching times vs. gate resistor R_G

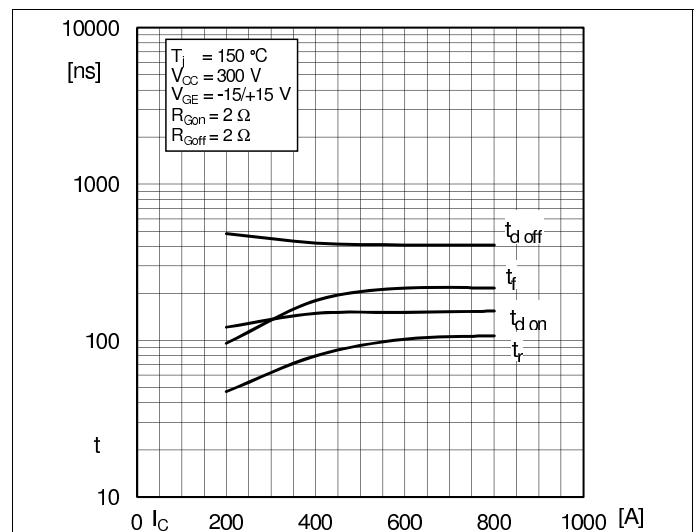

Fig. 14: Typ. switching times vs. I_c

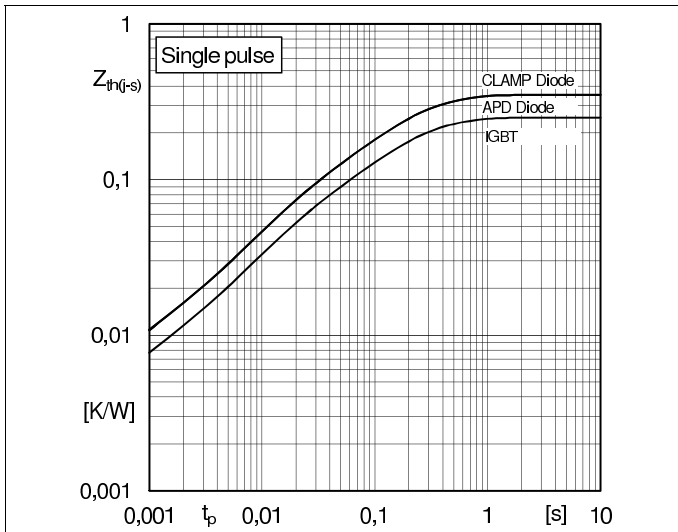
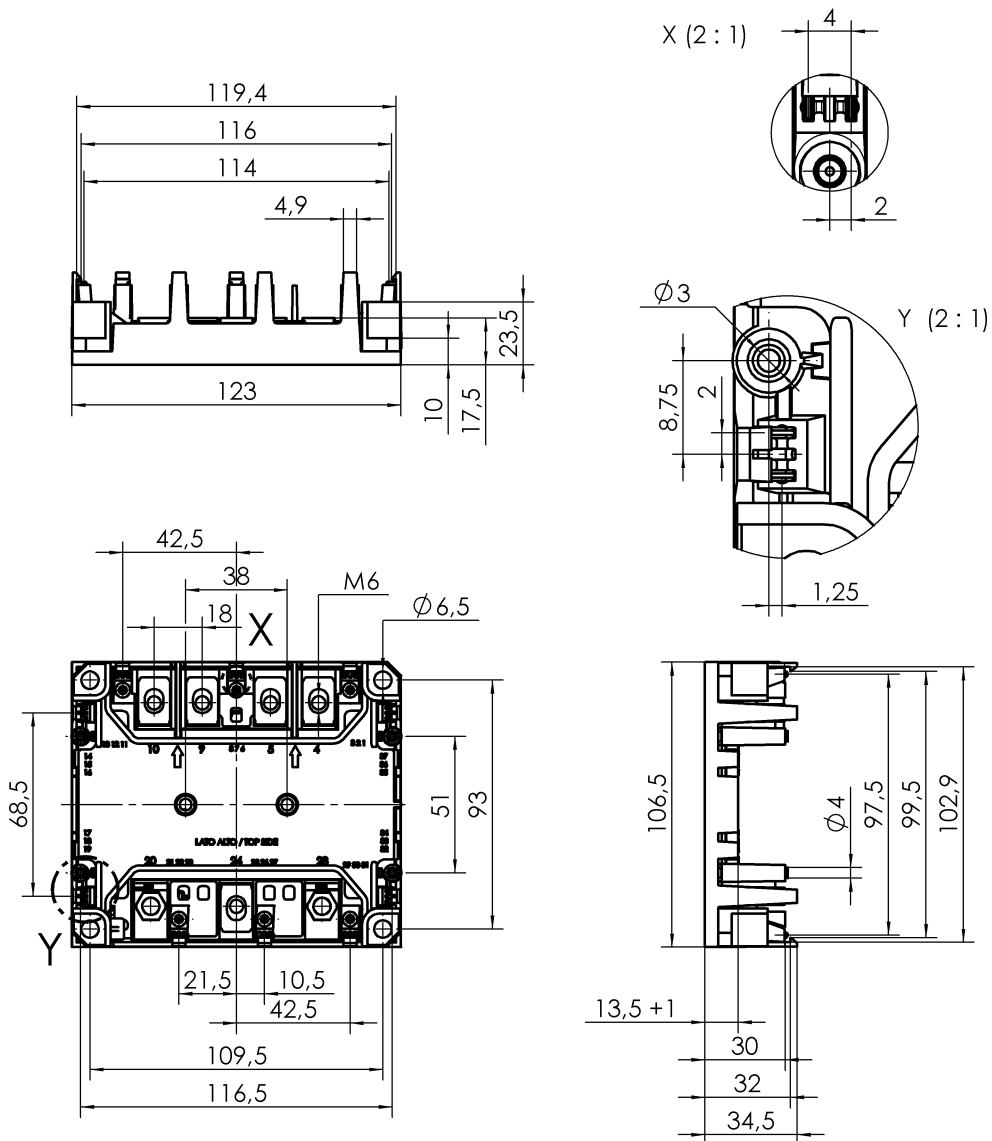
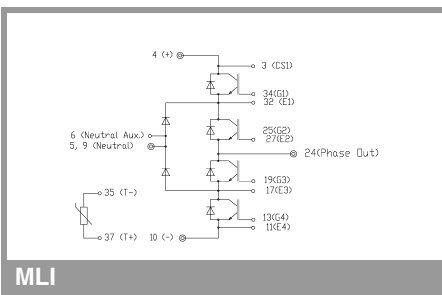

Fig. 15 Typ. IGBTs and DIODEs transient thermal impedance

SKiM401MLI07E4



SKiM 4



MLI

This is an electrostatic discharge sensitive device (ESDS), international standard IEC 60747-1, Chapter IX

* The specifications of our components may not be considered as an assurance of component characteristics. Components have to be tested for the respective application. Adjustments may be necessary. The use of SEMIKRON products in life support appliances and systems is subject to prior specification and written approval by SEMIKRON. We therefore strongly recommend prior consultation of our staff.